

KENWOOD

144/440 MHz FM DUAL BANDER

TM-732A

144/430 MHz FM DUAL BANDER

TM-732A

144/430 MHz FM DUAL BANDER

TM-732E

INSTRUCTION MANUAL

KENWOOD CORPORATION

Thank you for purchasing this new transceiver.

IMPORTANT:

Please read this instruction manual carefully before placing your transceiver in service.

CAUTION:

Long transmission or extended operation in the HI power mode might cause the rear of this transceiver to get warm.

Do not place the transceiver where the heat sink (rear panel) might come in contact with plastic or vinyl surfaces.

NOTE: If disregarded, inconvenience only, no risk of equipment damage or personal injury.

CAUTION: Equipment damage may occur, but not personal injury.

Save this instruction manual.

This instruction Manual covers the following models.

TM-732A:	144/440MHz FM DUAL BANDER (U.S.A. , CANADA version)
TM-732A:	144/430MHz FM DUAL BANDER (General markets)
TM-732E:	144/430MHz FM DUAL BANDER (European markets)

Notice to the user:

One or more of the following statements may be applicable to this equipment.

FCC WARNING

This equipment generates or uses radio frequency energy. Changes or modifications to this equipment may cause harmful interference unless the modifications are expressly approved in the instruction manual. The user could lose the authority to operate this equipment if an unauthorized change or modification is made.

Information to the digital device user required by the FCC:

This equipment has been tested and found to comply with the limits for a Class B digital device, pursuant to Part 15 of the FCC Rules. These limits are designed to provide reasonable protection against harmful interference in a residential installation. This equipment generates, uses and can generate radio frequency energy and, if not installed and used in accordance with the instructions, may cause harmful interference to radio communications. However, there is no guarantee that the interference will not occur in a particular installation. If this equipment does cause harmful interference to radio or television reception, which can be determined by turning the equipment off and on, the user is encouraged to try to correct the interference by one or more of the following measures:

- Reorient or relocate the receiving antenna.
- Increase the separation between the equipment and receiver.
- Connect the equipment into an outlet on a circuit different from that to which the receiver is connected.
- Consult the dealer for technical assistance.

⚠ WARNING BEFORE OPERATION

TO PREVENT ELECTRIC SHOCK, FIRE AND OTHER INJURY.

PLEASE NOTE THE FOLLOWING:

**The power requirement is 13.8 VDC.
Never attempt connection to a 24 VDC source.**

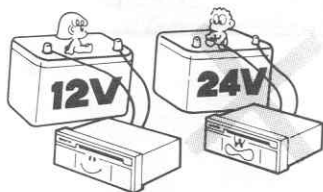

If an abnormal odor or smoke is detected, immediately turn the power off and disconnect the POWER cord. Contact your KENWOOD service station or your dealer.



Do not place this unit where it will be exposed to direct sunlight or close to heating appliances.

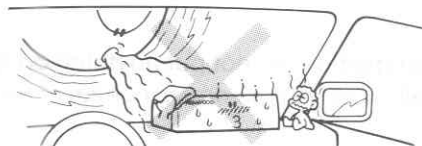

Do not place the unit in areas of excessive dust, high humidity or on unstable surfaces



Do not drop pieces of metal, needles, coins and other electrically conductive materials into the unit

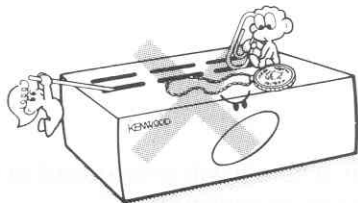

To ensure good ventilation, do not put anything on top of the cabinet and allow at least 15 cm (6 inches) of space behind the unit.

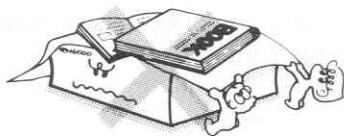

CLEANING

1. Turn the power off, before cleaning the unit.
2. Do not use any type of abrasive pad, thinner, benzine or any substances which may damage the unit.
3. Wipe the front panel and other exterior surfaces of the unit with a soft dry cloth or a soft cloth lightly moistened with water.



This Instruction Manual consists of the following sections:

SECTION 1 Basic transmit/receive and memory operation.

This section outlines the basic items you should know in order to properly operate the TM-732A/E.

- Installation to first turning on the equipment.
- Basic key functions and identification.
- Basic transmit/receive operation.
- Basic memory entry and recall operations.

SECTION 2 Mastering the TM-732A/E

This section provides detailed operating information for the TM-732A/E.

- Advanced transmit/receive functions.
- Detailed memory procedures.
- Detailed SCAN procedures.
- Repeater Operation
- Other useful functions.

SECTION 3 Specialized Communication Modes

This section provides detailed information on several tone signalling modes.

- CTCSS
- DTSS
- PAGING
- TONE ALERT System

SECTION 4 Useful information

This section provides general information.

- Maintenance
- In case of difficulty
- Optional Accessories

CONTENTS

■ BEFORE OPERATION	3
■ MANUAL ORGANIZATION	5
■ ACCESSORIES	9

SECTION 1 Basic transmit/receive and memory operation.

■ FRONT PANEL KEYS, CONTROLS, AND LABELING	10	■ RECEIVER OPERATION	25
■ INSTALLATION INSTRUCTIONS		■ TRANSMITTER OPERATION	27
1. Mobile Installations	12	■ MEMORY BASICS	
1-1. Mounting Bracket	12	1. Storing Information into Memory	29
1-2. Battery Connections	12	1-1. Normal Repeater Offset or Simplex Channel Entry	29
2. Fixed Station	13	1-2. Odd Split Memory Channel	29
3. Antenna	14	2. Memory Channel Recall	30
■ OPERATING CONTROLS			
1. Front Panel	15		
2. Display Panel	20		
3. Rear Panel and Side Case	21		
4. LED Display	21		
5. Microphone	22		

CONTENTS

SECTION 2 Mastering the TM-732A/E

- **ADVANCED RECEIVE FUNCTIONS**
 - 1. Simultaneous Reception of Two Signal in the Same Band 31
 - 2. A.B.C.(Automatic Band Change) 31
 - 3. MUTE 32
 - 4. Separating RX Audio Signals 32
 - 5. Microprocessor Squelch Control 32
 - 6. S Meter Squelch Control 33
- **ADVANCED TRANSMIT FUNCTIONS**
 - 1. Time-Out Timer (TOT) 34
 - 2. Locking the Transmit Band 34
 - 3. Transmit Frequency Selection during Simultaneous In-band Reception 34
- **MEMORY**
 - 1. Memory Capabilities 35
 - 2. Microprocessor Memory Back-up 37
 - 3. Microprocessor Defaults 37
 - 4. Memory Contents 37
 - 5. **RESET**
 - 5-1. Memory Reset 38
 - 5-2. VFO Reset 38
 - 6. Rewriting Call Channel Data 38
 - 7. Changing Data Stored in Memory. 39
 - 8. Memory Shift 39
- **SCAN**
 - 1. Band Scan. 40
 - 2. Programmable Band Scan. 41
 - 3. Memory Channel Scan 41
 - 4. CALL Scan 42
 - 5. MHz Scan 42
 - 6. Hold / Resume Programming. 42
 - 7. Memory Channel Lockout 43
- **REPEATER OPERATION**
 - 1. Transmitter Offset 44
 - 2. Reverse Function 44
 - 3. Tone Operation 45
 - 4. Autopatch Operations. 46
 - (U.S.A. version only)
 - 5. DTMF Memory 47
- **OTHER USEFUL FUNCTIONS**
 - 1. Dimmer (DIM) 48
 - 2. Beep Tone Level Adjustment 48
 - 3. Clearing the Unused Band Display 49
 - 4. Automatic Power Off (APO) 49
 - 5. Key Locks 50
 - 6. Programmable VFO Tuning Limits 51
 - 7. Frequency Step Selection. 51
 - 8. Beep Tone Frequencies 52
 - 9. Channelized Frequency Display. 52
 - 10. Pushbutton Control Using the DTMF Microphone 54
 - 11. Remote Control by External DTMF Signal 56
 - 12. Operation as a Repeater 58

CONTENTS

SECTION 3 Specialized Communication Modes

1. CTCSS Operation
 - 1-1. Tone Frequency Selection 59
 - 1-2. CTCSS setting 60
 - 1-3. Transmission 60
 - 1-4. Tone Squelch Operation 60
 - 1-5. Entering the Data into Memory 60
2. DTSS
 - 2-1. Preparation for DTSS Operation . . . 61
 - 2-2. DTSS Code 61
 - 2-3. DTSS Code Selection 61
 - 2-4. Entering Data into Memory 62
 - 2-5. Setting Delay Time 63
 - 2-6 Using the DTSS Function. 64
3. PAGING
 - 3-1. Paging Code Memories 65
 - 3-2. Code Selection 66
 - 3-3. Automatic Page Cancelling 67
 - 3-4. Code Lockout 68
 - 3-5. Cancelling Signal Squelch. 68
 - 3-6. Code Transmission 69
 - 3-7. Paging Code Monitoring 70
4. TONE ALERT SYSTEM
 - 4-1. Tone Alert Operation. 71
 - 4-2. Alarm Sound Selection 72

SECTION 4 Useful information

1. MAINTENANCE 73
2. IN CASE OF DIFFICULTY 74
3. OPTIONAL ACCESSORIES 76
4. INSTALLING OPTIONAL ACCESSORIES 77
 - 4-1. CTCSS unit (TSU-7) 77
 - 4-2. PANEL SEPARATION KIT (PG-4K/4L) 77
5. SPECIFICATIONS 79

ACCESSORIES

Unpack your new transceiver carefully, and examine it for visible damage. If the equipment has been damaged in shipping you should notify the shipping company immediately.

DTMF Microphone	T91-0517-XX	1
(U.S.A. and CANADA only)		
or Microphone	T91-0521-XX	1
(European version)		
or Microphone	T91-0516-XX	1
(General market)		
Microphone Hook	J20-0319-XX	1
(U.S.A. and CANADA only)		
Mobile Mounting Kit		
Bracket	J29-0436-XX	1
Screw set	N99-0331-XX	1
Self tapping Screw	N46-3010-46	2
(U.S.A. and CANADA only)		
Hex Wrench	W01-0414-XX	1
DC power Cable	E30-2111-XX	1
Fuse (15A)	F05-1531-XX	1
Instruction Manual	B62-0201-XX	1 copy
Warranty Card		1
(U.S.A., CANADA and European version only)		

After unpacking

Shipping container:

Save the box and packing in the event your unit needs to be transported for remote operation, maintenance, or service.

SECTION 1 Basic transmit/receive and memory operation.

FRONT PANEL KEYS, CONTROLS, AND LABELING

VFO: Variable Frequency Oscillator

This key is used to select the VFO mode. This mode allows you to select the desired frequency by turning the main tuning control or with the UP/DWN pushbuttons on the microphone.

M▶V:

Pressing the F key momentarily and then this key will copy the contents of the current memory channel to the VFO.

MR: Memory Recall

This key is used to select the MR mode.

This mode allows you to select the desired memory channel by turning the main tuning control or with the UP/DWN pushbuttons on the microphone.

M: Memory

Pressing the F key momentarily and then this key will write current VFO information into memory.

VOL: Volume

This control is used to adjust the volume from the internal and external speaker (if used.) Clockwise rotation will increase the volume and counterclockwise rotation will decrease the volume.

SQL: Squelch

This control is used to select the desired squelch threshold level. (Eliminates the background noise when no signal is present.)

MHz:

This key is used to select 1 MHz tuning steps.

LOCK:

Pressing the F key momentarily and then this key will disable all front panel keys preventing accidental frequency shifts, etc.

Tuning control:

Use this control to select the desired operating frequency, memory channel, etc.

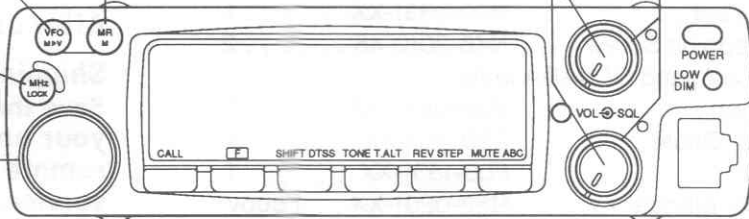

C.SEL: Control Selector

This key is used select which band will be controlled by the tuning control, etc.

POWER:

Turns the power on and off.

LOW:

This key is used to select the desired transmitter output power.

DIM: Dimmer

Used in conjunction with the F key to select the desired front panel display illumination intensity.

MUTE:

This key is used to reduce the received audio level of one band, when you are transmitting on the other.

ABC: Automatic Band Change

Used in conjunction with the F key to activate the ABC function. See page 31 for additional information on this function.

REV: Reverse

This key is used to reverse the transmit/receive frequencies during repeater operation. This key does not function in the simplex mode.

STEP:

Used in conjunction with the F key to program the tuning step size.

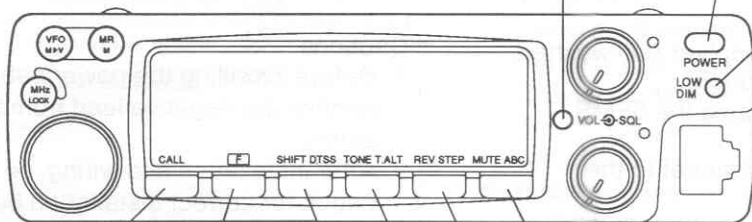
**CALL:**

Call channel. When this key is pressed, the call channel is selected.

F: Function

This key is used in conjunction with other front panel keys to reconfigure the transceiver. See the charts on pages 15-19 for additional information on the various configurations.

SHIFT:

Selects the desired transmitter offset for repeater operation.

DTSS:

Dual Tone Squelch System
Used in conjunction with the F key to activate the DTSS system.
See page 61 for additional information on this function.

TONE:

This key is used to activate the sub-audible tone encoder.

T.ALT: Tone Alert

Used in conjunction with the F key to activate the Tone Alert function. See page 71 for additional information on this function.

■ INSTALLATION INSTRUCTIONS

1. Mobile Installations

1-1. Mounting Bracket

Notes

1. When installing the transceiver consider ease of operation and safety when selecting the location for the mounting bracket.
 2. Install the bracket securely so that it will not come off due to vibration.
1. Install the bracket using the supplied flat washers and self tapping screws (4 pcs. each).
 2. Attach the transceiver loosely using the SEMS screws (4 pcs.).
 3. Adjust the viewing angle of the bracket to the desired position .
 4. Hold the transceiver in place and tighten the 4 SEMS screws using the supplied wrench.

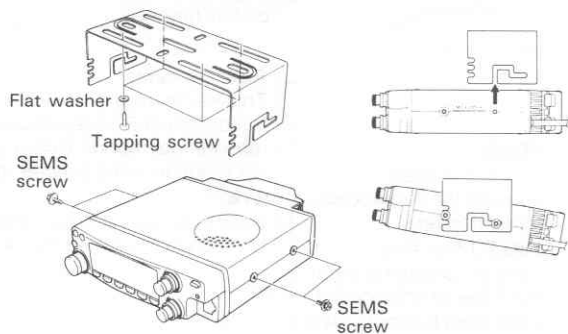

Caution

Leave enough space around the fan on the rear panel for good ventilation.

1-2. Battery Connections

Connect the power cable directly to the battery terminals. Use of the cigarette lighter socket will lead to poor connection, and will result in poor performance. Pay close attention to the polarity of the cables when connecting them to the battery.

Cautions

1. Before installing the power cable, be sure to remove the negative lead from the battery for safety.
2. After installation and wiring, be sure to double check for correct installation before reconnecting the negative lead to the battery terminal.
3. If the fuse opens, be sure to check that each conductor has not been damaged by short circuiting, etc. Then replace with a new fuse of the same rating.
4. After completing the wiring, wrap the fuse holder with heat resistant tape to protect against heat and moisture.
5. Do not remove the fuse even if the power cable is too long.

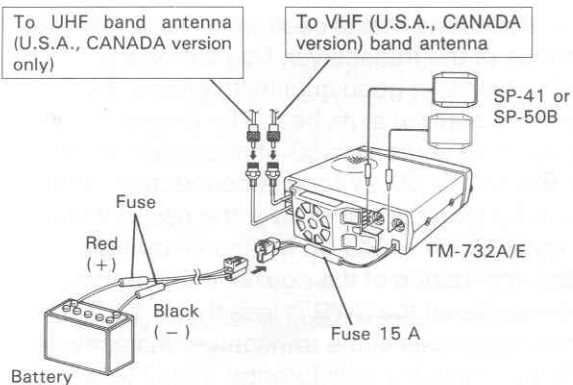

2. Fixed Station

A regulated DC power supply (13.8 VDC capable of supplying at least 12 Amperes) is required. The PS-33 and the PS-53 are recommended.

Caution :

1. Never connect the AC power cable to the AC outlet until all other connections have been made.
2. Before connecting and disconnecting the power connector, be sure to turn OFF the POWER switches of both the transceiver and the DC power supply.
3. Observe polarity of the DC power cable. The transceiver operates on 13.8 VDC, negative ground. Battery polarity must be correct. The power cable is color coded :

Red → + (Positive polarity)

Black → - (Negative polarity)

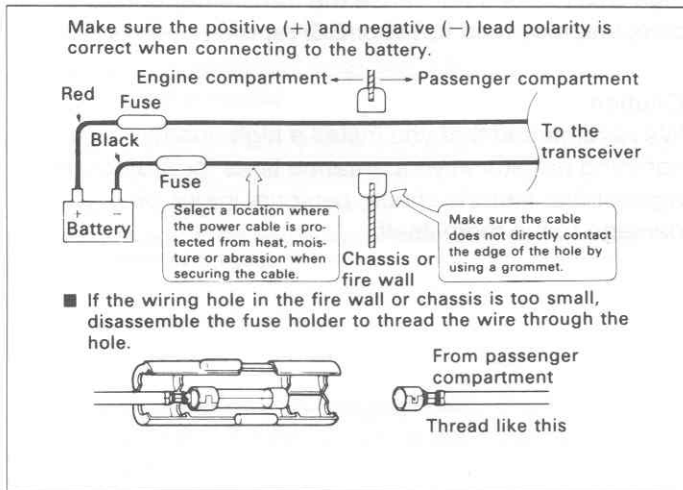

Caution :

Leave enough space around the fan on the rear panel for good ventilation.

3. Antenna

The type of antenna that is used will greatly affect the performance of the transceiver. Use a properly adjusted antenna, of good quality, to enable your transceiver to perform at its best. The antenna input impedance is 50 ohms. Use 50-ohm coaxial cable such as RG-58U or 5D-2V for this connection. If the antenna is far from the transceiver the use of low loss coaxial cable, such as RG-8U is recommended. Match the impedance of the coaxial cable and that of the antenna so that the SWR is less than 1.5 to 1. The protection circuit in the transceiver will activate if the SWR is particularly poor (greater than 3 to 1). High SWR values will cause the transmitter output to drop, and may lead to TVI or BCI reports.

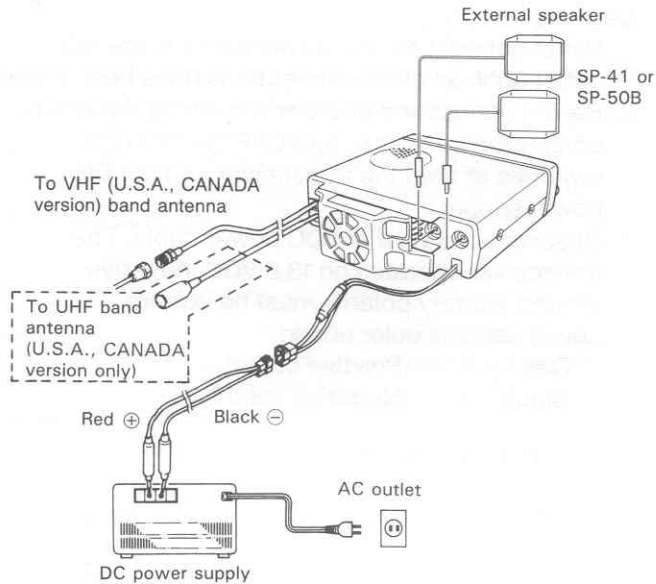

Caution :

We recommend that you install a high quality lightning arrester in your antenna lines for protection against fire, electric shock, personal injury, or damage to the radio itself.

OPERATING CONTROLS

1. Front Panel

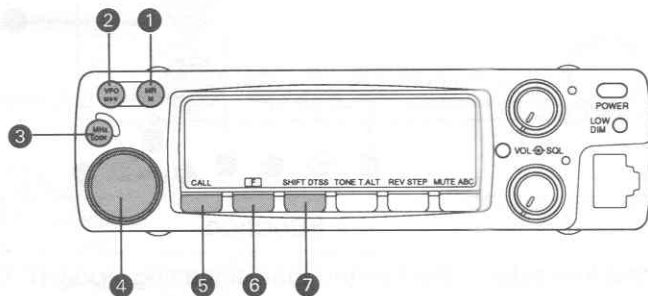

No	Key	Function	Page
1	MR/M	This key is used to select the MR mode. This mode allows you to select the desired memory channel by turning the main tuning control or with the UP/DWN pushbuttons on the microphone. Pressing the key for longer than 1 second will initiate memory channel scan.	30 41
2	VFO/M▶V	This key is used to select/return to the VFO mode after operating in the MR or CALL channel mode. Pressing this key will allow the tuning control and microphone UP/DWN keys to control the operating frequency. Press and hold the key for longer than 1 second to initiate VFO scan.	40
3	MHz/LOCK	This key is used to select a 1 MHz tuning step.	—
4	Tuning control	This control is used to select the desired transmit/receive frequency, MHz step, Memory Channel, Frequency Step, Tone Frequency, Scan Direction, etc.	—
5	CALL	Press this key to activate the call channel function. Pressing the key for longer than 1 second will initiate CALL scan.	42
6	F	This key is used in conjunction with other front panel keys to reconfigure the transceiver.	—
7	SHIFT/DTSS	Selects the desired transmitter offset for repeater operation. Each time the key is depressed the offset will shift once, i.e. " + " to " - ", or " - " to " - " (Simplex), or " - " to " + ". [" - " to " - " for European versions.]	44

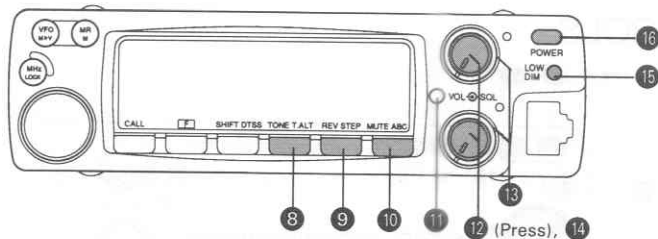

NO	Key	Function	Page
8	TONE/T.ALT	Pressing this key selects the desired tone signalling mode: (T, CTCSS, OFF)	45, 60
9	REV/STEP	This key is used to reverse the transmit/receive frequencies during repeater operations. This key will not function in the simplex mode.	44
10	MUTE/ABC	This key is used to lower the receiver audio level by -20dB during transmit.	32
11	C.SEL	This key is used to select the band you wish to control with the front panel switches, etc., without affecting the transmit band selection. (Use the BAND SELECT keys to select the desired transmit band.) A green indicator will light to show which band will be controlled by the front panel controls.	—
12	BAND SEL (Press)	These keys are used to select the desired transmit band. They can also be used to select the control band. When one of these keys is pressed the "PTT" indicator will flash in the selected frequency display as a visual indicator. A green indicator will light to show which band will be controlled by the front panel controls.	—
13	SQL controls	These controls are used to independently adjust the squelch threshold for each band.	—
14	VOL controls	These controls are used to independently adjust the receiver audio level for each band.	—
15	LOW/DIM	This key is used to select the transmit output power level.	27
16	POWER	This key is used to turn the transceiver's power ON or OFF.	—

Basic functions performed with the F key

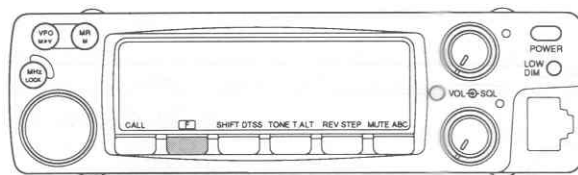

Press the F key momentarily and then, within 10 seconds, press one of the following keys:

Key	Function	Page
VFO/M▶V	Copy memory data into the VFO.	39
MR/M	Write data into memory.	29, 30
MHz/LOCK	Inhibit all keys except the PTT key and the F+MHz key.	50
CALL	Change call channel data.	38
SHIFT/DTSS	Change DTSS/Page data.	61, 66
TONE/T.ALT	Turns the Tone Alert function On and OFF.	71
REV/STEP	Change the VFO Step size.	51
MUTE/ABC	Turns the Automatic Band Change function ON and OFF.	31
LOW/DIM	Selects the display lamp intensity.	48
C. SEL	Receive signals in the same band simultaneously.	31
BAND SEL	Select the desired transmit band, VHF or UHF.	25

Press and hold the F key for 1 second or longer, then press one of the following keys:

Key	Function	Page
VFO/M▶V	Change Scan Hold/Resume mode.	42
MR/M	Memory channel lockout.	43
MHz/LOCK	Turns the Automatic Power Off function on and off.	49
CALL	Change hangup time.	58
SHIFT/DTSS	Used to program the DTSS or Paging code.	61, 66
TONE/T.ALT	Tone frequency selection.	45, 59
REV/STEP	Beep tone level adjustment.	48
MUTE/ABC	Cross Band Repeater ON/OFF control.	58
LOW/DIM	Selects noise activated squelch or S-Meter squelch.	33
C. SEL	Selects the external speaker receiver input.	32
BAND SEL	Band ON/OFF control.	49

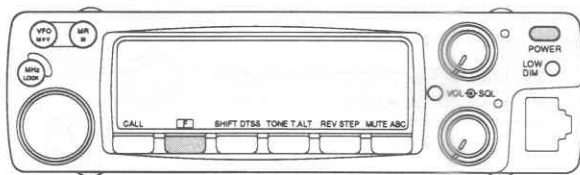

Press and hold the F key and then press one of the following keys:

Key	Function	Page
VFO/M▶V	Check program scan frequency limits.	41
MR/M	Memory channel clear.	38
MHz/LOCK	Enter the program scan frequency limit	41
CALL	Used the set the program VFO scan lower frequency.	51
SHIFT/DTSS	Used the set the program VFO scan upper frequency.	51
REV/STEP	Automatic paging cancel.	67
LOW/DIM	S-Meter squelch hysteresis selection.	33
C. SEL	Enables DTMF microphone remote control	54

Press and hold the F key and the key indicated below, and then turn on the power.

Note: You must hold the keys down until the display turns on to the normal intensity. (About 2 or 3 seconds.)

Key	Function	Page
VFO/M▶V	Assigns the ENTER function to the PF key on the DTMF microphone.	22
MR/M	Change the memory channel allocation.	36
CALL	DTMF signal memory	47
SHIFT/DTSS	Tone alert selection	72
TONE/T.ALT	Musical frequency indication.	52
LOW/DIM	Increases the display intensity for 5 seconds after a key is pressed or a knob is turned.	48

Basic functions performed with the POWER key

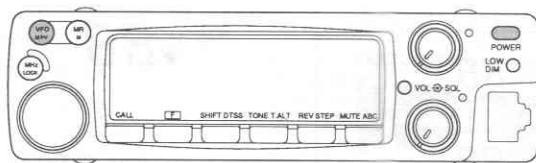

Press and hold the indicated key while the power is turned on.

Note: You must hold the key down until the display turns on to the normal intensity. (About 2 or 3 seconds.)

Key	Function	Page
VFO/M	VFO reset	37
MR/M	Master Memory Reset	37
MHz/LOCK	Enables/disables ALL LOCK . Microprocessor Squelch control if no lock is activated	50
F	The PF key can be assigned to the ENTER function (for the DTMF microphone only)	22
SHIFT/DTSS	DTSS code transmission time change	63
REV/STEP	Channel display ON/OFF control.	52
LOW/DIM	Time out Timer ON/OFF control.	34
C. SEL	External DTMF tone Remote Control	56
BAND. SEL	Signal Squelch ON/OFF control.	68

Press and hold the VFO key and one of the following keys and turn on the power.

Note: You must hold the keys down until the display turns on to the normal intensity. (About 2 or 3 seconds.)

Key	Function	Page
BAND SEL. V	VHF band VFO reset	37
BAND SEL. U	UHF band VFO reset	37

2. Display Panel

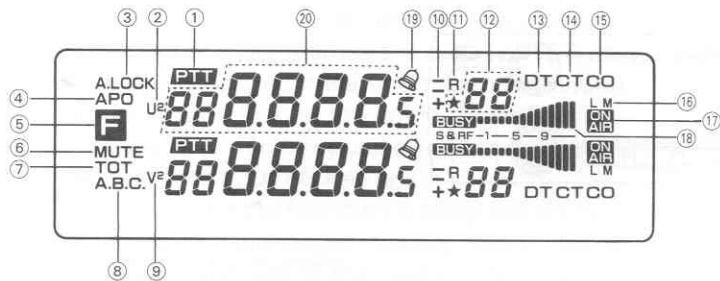

- ① **PTT** Indicates the TX band.
- ② **U²** On when two UHF band signals are received at the same time.
- ③ **A. LOCK** On when the Lock function has been activated.
On when the All Lock function has been activated.
- ④ **APO** On when the Automatic Power Off function has been activated.
- ⑤ **F** On whenever the F key has been depressed.
- ⑥ **MUTE** On when the volume of the RX band is reduced.
- ⑦ **TOT** On when the Time-Out Timer function has been activated.
- ⑧ **A.B.C.** On when the Automatic Band Change function has been activated.
- ⑨ **V²** On when two VHF band signals are received at the same time.
- ⑩ **-**
+ Displays the selected transmitter offset direction.

- ⑪ **R** On when the Reverse function has been activated.
- ⑫ **★ 88** Shows the last memory channel number that was selected. The ★ indicator is on when the Memory channel will be skipped during Memory channel scan.
- ⑬ **DT** On when the DTSS function is active.
- ⑭ **CT** With the optional CTCSS unit TSU-7: On when the Tone Decode function is active.
On when the Tone Encode function is active.
- ⑮ **CO** On when Carrier Operated scan is selected.
- ⑯ **L M** Indicates the relative output power setting for transmit. No indicator indicates full power.
On during transmit.
- ⑰ **ON AIR**
- ⑱ **BUSY** This level meter indicates the relative receiver signal strength or the relative transmitter power output.
On when the squelch opens.
On when the Tone Alert function is active.
- ⑲  On when the Tone Alert function is active.
- ⑳ **888888.5** Displays the operating frequency to the nearest kHz digit, or the tone frequency.
The indicator flashes when scanning.

3. Rear Panel and Side Case

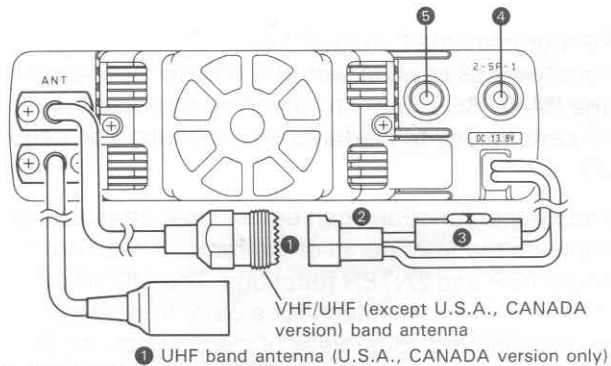

① ANTENNA connector

Attach an antenna with a low SWR and impedance of 50 ohms.

② 13.8 VDC power input connector

Connect the supplied DC power cable to this connector.

Pay close attention to the polarity. Red is positive and black is negative.

③ Fuse holder

Contains a 15A fuse. Do not use a larger fuse as damage might result to the transceiver.

④ External speaker jack (SP 1)

When an external speaker is connected to this jack receiver audio will be heard from the internal and external speaker.

You can specify which bands receiver audio is applied to the external speaker. (See page 32 for additional information on this feature.)

⑤ External speaker jack (SP 2)

The speaker should have an impedance of 8 ohms. The internal speaker is disabled when the external speaker is attached to this jack.

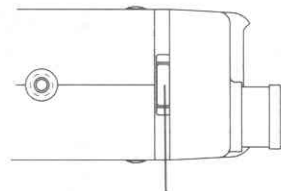

Release button

Press this button to release the panel.

4. LED Display

On when the top display band can be controlled.

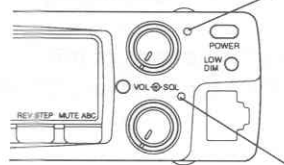

On when the lower display band can be controlled.

5. Microphone

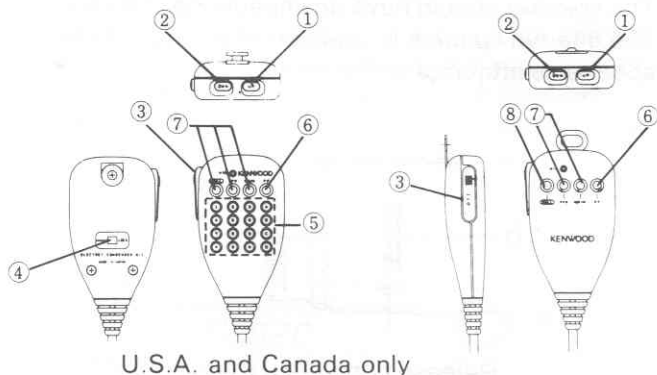

U.S.A. and Canada only

①②UP/DWN switches

These switches can be used to increase or decrease the VFO frequency, the Memory channel number, and the Tone frequency, etc..

③PTT(Push to Talk) switch

The transceiver will transmit whenever this switch is depressed. Scan operations may be canceled by pressing this switch without transmitting.

④LOCK

This key will deactivate all functions of the microphone except the PTT function and DTMF keypad.

⑤16-Tone DTMF keypad

These buttons are used to activate the DTMF encoder.

⑥PF(Programmable Function) key

This key has been preset at the factory to perform the BAND SEL function. It can be reprogrammed to perform any of the functions described on page 23.

Two additional functions can be assigned that are not available on the front panel of the radio. These are the MONITOR and ENTER functions. The MONITOR function allows you to check for a clear frequency before transmitting, regardless of the Squelch mode that has been selected. The ENTER function allows you to directly enter the desired operating frequency using the DTMF keys on the DTMF Microphone.

MONITOR programming

Press and hold the F key on the front panel as you turn on the power key.

ENTER programming

1. Turn the POWER switch OFF.
2. Press and hold the F key and the VFO key while you turn the power switch ON.

Example: Select a frequency of 145.640 MHz

1. Press the upper BAND SEL key on the transceiver to select the VHF band.
2. Press the DTMF Microphone PF key
The VHF frequency display will show: 1- - . - - .
(14 - . - - : except U.S.A, CANADA version)

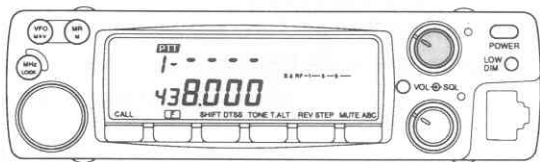

3. Press the 4, 5, 6, 4, 0 keys on the DTMF keypad in sequence.

NOTES

1. If no key is pressed within 10 seconds of pressing the PF key the operation will self cancel.
2. If the PF key is pressed while entering the frequency, or any key other than the PF key or numeric keys is pressed the frequency display will revert to the frequency that was displayed before the PF key was depressed.
3. If an invalid number key is pressed during frequency entry (such as 19X.XXX.) the closest valid key value will be entered. (Using the previous example the radio would enter a 7, since this is the closest valid entry for the 10 MHz position.)
4. If an invalid numeric key is pressed, the value nearest to that number is entered.

⑦CALL key VFO key MR key

These keys function just like the CALL, VFO, and MR keys on the front panel of the radio.
(See page 15.)

○ Reprogramming the function keys on the DTMF Microphone.

1. Hold down the desired key and turn the transceivers power switch ON.
When the PF key is selected "PF1" will appear in the display. When the MR key is selected "PF2" appears. When the VFO key is selected "PF3" appears, and "PF4" appears when the CALL key is selected.
2. Pressing any valid control key sequence will cause that sequence to be assigned to the corresponding microphone key.
 - Basic functions performed by pressing a panel key
 - Function performed when the F key is pressed, and a panel key pressed within 10 seconds
 - Function performed when the F key is held down for at least one second, and a panel key pressed while the F indicator is flashing
 - Function performed when the F key is held down, and a panel key pressed

Example:

Assign the M▶V function to the PF key on the microphone.

1. Press and hold the PF key on the microphone while the transceiver power is turned on. PF1 will appear in the display.
2. Press the F key on the front of the radio momentarily, and then press the VFO/M▶V key.
3. This assigns the M▶V function to the PF key on the microphone.

The function is cancelled by resetting the memory.
(See page 38.)

Ⓢ1750key (European version)

The transceiver will transmit with 1750 Hz repeater access tone whenever this switch is depressed.

RECEIVER OPERATION

Before switching the power on, set the controls as follows:

(Fixed station): Regulated DC stabilized power supply power switch: Off

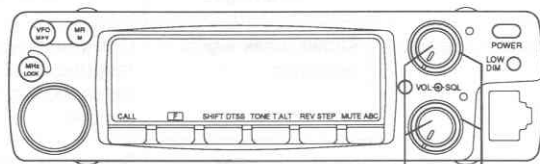

Both Vol Control
Full Counterclockwise

Both SQL Control
Full Counterclockwise

The following example will prepare the transceiver to receive a frequency of 145.020 MHz.

1. First turn on the regulated DC power supply, then press the POWER key on the front of the transceiver.

A frequency will be displayed after a delay of approximately 1 second. The factory default for the 2 meter band is 144.000 and the default for 70 cm is 440.000 (or 430.000 for some destinations.)

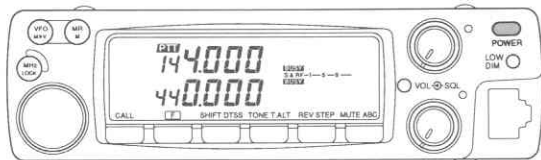

2. Press the upper BAND SEL key to select the 2 Meter band.

Pressing the upper BAND SEL key permits control of the 2 Meter band with the various front panel controls etc.

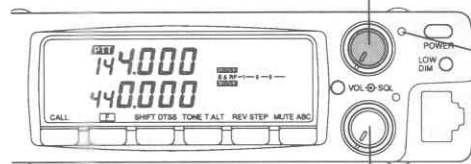

The LED lights.

Pressing the lower BAND SEL key permits control of the 70 cm band with the various front panel controls etc.

3. Turning the upper VOL control in a clockwise direction will permit a signal, or noise to be heard from the speaker. Adjust the VOL control to a comfortable level.
4. Rotate the tuning control and select an open frequency (no signal is present.)

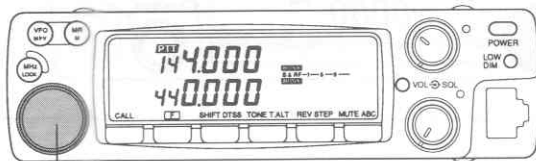

When the tuning control is rotated in a clockwise direction the frequency increases, rotating the control counterclockwise decreases the frequency.

5. Rotate the SQL control clockwise until the noise just disappears

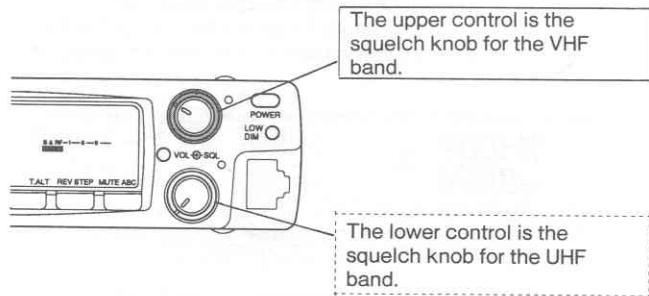

6. Select the desired operating frequency(145.020MHz) using the microphone or tuning control. When a signal is received the S-meter will deflect and the BUSY indicator will turn on.

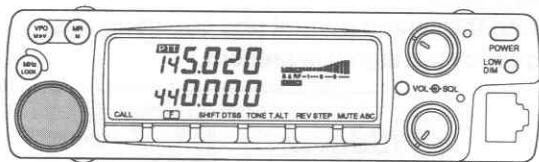

UHF band

Pressing the lower BAND SEL key permits control of the 70 cm band with the various front panel controls etc. Operation is similar to the 2 Meter band operations described above.

Squelch Basics

The positioning of the squelch control will affect the receiver performance. The chart below summarizes the characteristics of the squelch control settings.

Squelch Control Position	Advantages	Disadvantages
Constant background noise.	Allows weak signal reception.	Constant noise can be fatiguing over extended listening periods.
Background noise just disappears.	Relatively weak signals can be heard without constant background noise.	Squelch is sometimes opened by noise.
Control is advanced past the point where the background noise just disappears.	Noise does not tend to open the squelch.	Weak signals are not heard. Voice signals sometimes are interrupted by the squelch circuit action.

See page 32 for details on microprocessor controlled squelch.

TRANSMITTER OPERATION

The following example will prepare the transceiver to transmit on a simplex frequency of 145.020 MHz.

1. First turn on the the regulated DC power supply, then press the POWER key on the front of the transceiver.

A frequency will be displayed after a delay of approximately 1 second. The factory default for the 2 meter band is 144.000 and the default for 70c meters is 440.000 (or 430.000 for some destinations.)

The PTT indicator for the VHF band lights.

Pressing the upper BAND SEL key permits control of the 2 Meter band with the various front panel controls etc.

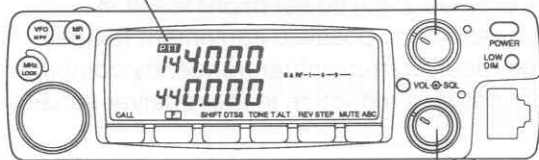

Pressing the lower BAND SEL key permits control of the 70 cm band with the various front panel controls etc.

2. Press the upper BAND SEL key to select the 2 Meter band.
3. Select the desired transmit frequency using the tuning control or the microphone UP/DWN controls.

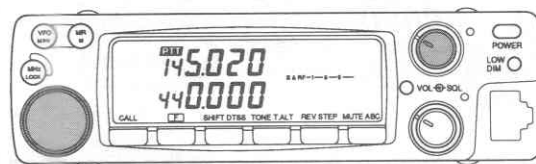

4. Select the desired transmitter power output. Pressing the LOW/DIM key steps from high (no indicator in the display), to medium (M indicator appears in the display), to low (L indicator), and back to high.

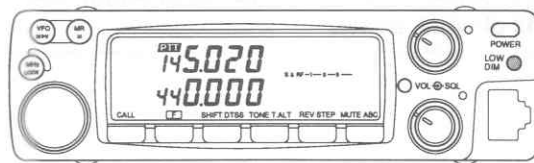

5. Press the microphone PTT bar and speak into the microphone. The recommended distance to the microphone is 5 cm (2 inches.) The ON AIR indicator will light in the display and the meter will indicate the relative power output.

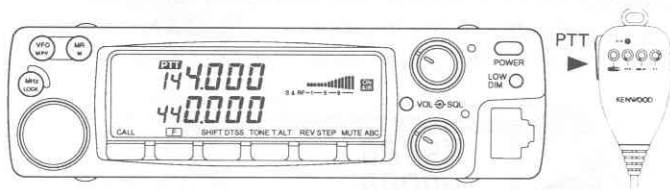

Note:

If the selected receiver frequency of the other band is 3 times your transmit frequency (the third harmonic) you might hear yourself transmitting.

Note:

Talking closer to the microphone might result in over deviation of your transmit signal, which might be reported as a loss of clarity or as an excessively wide transmit signal. Talking too far away might result in reports of weak audio.

6. Release the PTT switch to return to receive. The ON AIR indicator should go out, and the RF meter should return to zero.

Simultaneous reception on the other band is possible during transmit.

Notes

1. Before starting to transmit you should confirm that the frequency is open.
2. If you anticipate a long key-down period (such as might occur with RTTY, PACKET, SSTV, etc. you should reduce the output power. Transmitting for long periods at full power might result in overheating and possible equipment failure.
3. Some receiver/transmitter frequency combinations might cause a reduction in the receiver sensitivity.

MEMORY BASICS

1. Storing Information into Memory

1-1. Normal Repeater Offset or Simplex Channel Entry

Note: The TM-732A has been preprogrammed to automatically select the proper offset according to the ARRL Bandplan.

For example, 145.020 MHz is put into memory channel 5.

1. Press the upper BAND SEL key.
2. Select the desired receiver frequency, tone information etc. (For example 145.020MHz)

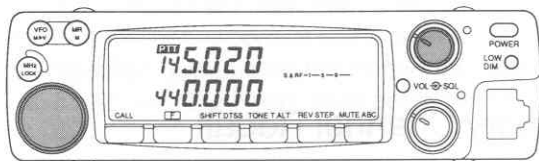

3. Press the F key momentarily. The F indicator will light on the display, and a memory channel number will appear.
4. Select any memory channel using the Tuning control or microphone UP/DWN keys. (For example: CH5)

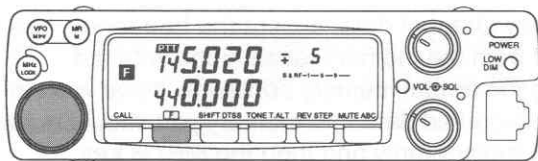

5. Press the MR key within 10 seconds of selecting the memory channel number. The F indicator and memory channel number will turn off. This signals that the data has been properly stored in memory.

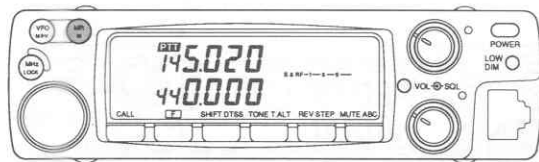

1-2. Odd Split Memory Channel

For example, put a receive frequency of 145.020 MHz and transmit frequency of 145.620 MHz into memory channel 10.

1. Press the upper BAND SEL key.
2. Select the desired receiver frequency, tone information etc. (For example 145.020MHz)

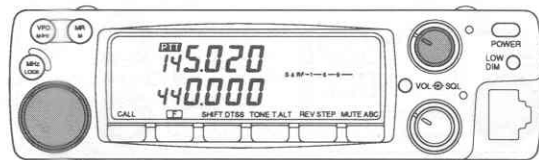

- Press the F key momentarily. The F indicator will light on the display, and a memory channel number will appear.
- Select any memory channel using the Tuning control or microphone UP/DWN keys.
(For example: CH10)

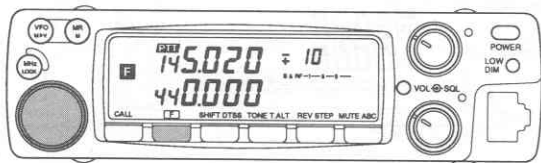

- Press the MR key for longer than 1 second within 10 seconds of selecting the memory channel number. The F and memory channel indicators and the “-” and “+” indicators disappear, then the “-” and “+” indicators light again, and the transmit frequency setting mode is entered.
- Select the desired transmit frequency.
(For example 145.620MHz)

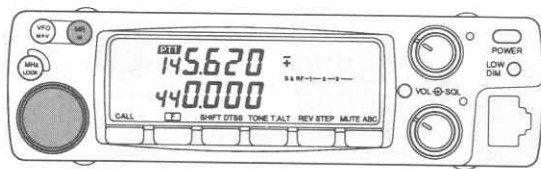

- Press the MR key.

To confirm the contents of the odd split memory channel:

Press the MR key. The programmed receiver frequency should appear in the display along with both a “-” and “+” offset direction indicator. This signals you that this channel has an odd split entered.

To check the transmit frequency press the REV key. The transmit frequency will appear in the display.

2. Memory Channel Recall

- Press the MR key to select the memory mode. The memory channel that was used previously will appear in the display.
- Rotate the Tuning control or press the microphone UP/DWN keys to select the desired memory channel.

Note:

All memory channel data, except the frequency, can be changed from the memory recall mode without affecting the actual memory contents. If you wish to store the modified data into memory you should press the F key momentarily and then the MR/M key.

3. MUTE

When a signal is received on the transmit band, the receiver volume for the other band is reduced automatically to make the incoming signal easy to hear. This function is called muting. To select this function, press the MUTE/ABC key. The MUTE indicator will appear in the display. When a signal is received on the transmit band (the PTT indicator lights), and the volume for the other band is reduced to 1/10.

To cancel
Press the MUTE/ABC key again.

4. Separating RX Audio Signals

Receive audio signals can be separated by connecting an external speaker (option).

When a single external speaker is connected to the SP1 jack.

Normally the audio is distributed as shown in the diagram below. This combination can be reversed. Press the F key for longer than one second, then press the C.SEL key while the F indicator is flashing.

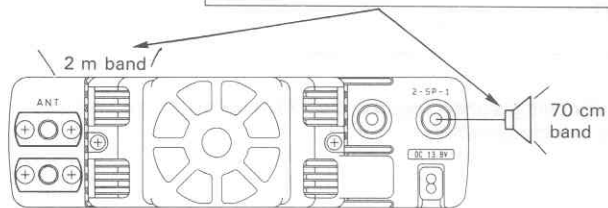

When two external speakers are connected to one SP1 and another to SP2

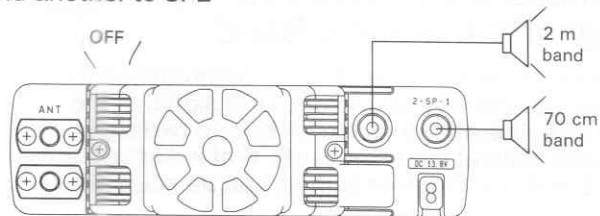

When an external speaker is connected only to SP2, the internal speaker is turned off, and the receive audio for both bands is output from SP2. The SP-50B or SP-41 are recommended for those connections.

5. Microprocessor Squelch Control

Squelch operation may be controlled by the microprocessor to automatically select the threshold point without operating the SQL control. When this function is selected, you do not need to adjust the SQL control. This function can be set for each band.

1. Turn the POWER switch off.
 2. Hold down the MHz key, then press the POWER switch.
 3. Press the BAND SEL key for the band in which the function is to be set.
 4. Hold down the F key, then press the LOW key.
- To cancel squelch microprocessor control, switch the power off and perform step 2.

6. S Meter Squelch Control

The normal method of opening squelch on a receiver is by detecting the noise level on the signal. This method is good, but does not allow precise threshold control. By changing to S-Meter squelch control you can set the squelch threshold so that it does not open until a specific S-Meter reading is obtained.

Function Selection

This function can be selected for both bands, if desired.

1. Press the VOL control on the band that you want to set.
2. Press the F key for longer than 1 second, the F indicator will begin to flash in the display. Then press the LOW key while the F indicator is flashing.
3. When the SQL control is rotated the S-Meter indicators will light up in the display. The Squelch control can be turned until the S-Meter indicates the minimum S-Meter level that will have to be obtained before squelch will open.

Signals below this level will not open squelch.

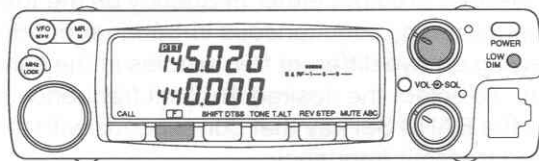

To return to noise activated squelch repeat step number 2.

The amount of time it takes for the squelch to close again, in the S-Meter squelch mode, is determined by a time delay circuit. This is to prevent the squelch from closing during momentary signal dropouts.

The factory preset is 500 mseconds. To change the delay:

Delay Selection

Note: You must deactivate microprocessor controlled squelch to program this function. See Page 32. Microprocessor squelch control.

1. Hold down the F key, then press the LOW key.
2. Select the desired delay time by turning the tuning control. (OFF, 125, 250, or 500)

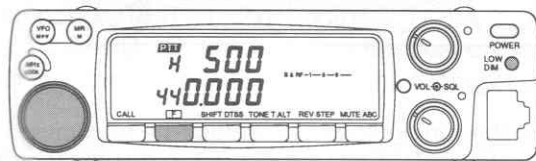

3. Press any front panel key to return to the normal display.

A quick method of determining which squelch mode is active is to turn the squelch control. If the S-Meter reading changes you are in the S-Meter squelch mode.

■ ADVANCED TRANSMIT FUNCTIONS

1. Time-Out Timer (TOT)

A Time-out-timer function has been provided to protect the radio from accidentally locking the unit in transmit for long time periods. This function allows you to specify the maximum transmit key down time.

Options include; 3, 5, 10, 20, 30, or no time limit.

(The factory default is no time limit.)

Function selection

1. Turn the power switch OFF.
2. Press and hold the LOW key and turn the power ON.
The current selection will appear in the display.

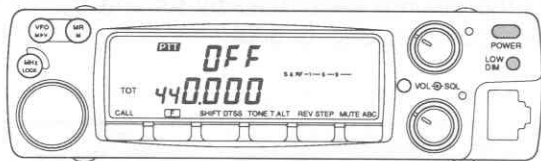

3. Turn the tuning control to select the maximum key down time. TOT will appear in the display for all selections except OFF.
4. Press any key to return to the normal frequency display.

If you should activate the Time-out-timer function a beep will sound from the speaker and the transceiver will return to the receive mode. You will need to press the PTT switch to transmit again.

2. Locking the Transmit Band

It is possible to lock the transceiver so that the transmit band is not accidentally changed. This locks the second band into a receive only mode.

Function selection

1. Press the F key momentarily.
2. Press the BAND SEL key that corresponds with the desired transmit only band. A dot will appear to the right of the 100kHz column to indicate which band is transmit only.

To cancel the assignment press repeat steps 1 and 2

3. Transmit Frequency Selection during Simultaneous In-band Reception.

It is possible to select either frequency as the transmit frequency during simultaneous in-band reception (receiving on two different frequencies in the same band). To select the desired transmit frequency simply press the BAND Sel key that corresponds with the desired transmit frequency.

Note:

Reception on the other frequency will not be possible while the PTT key is depressed.

MEMORY

1. Memory Capabilities

The TM-732A has a flexible memory system that allows the operator to tailor the number of memory channels available to match their own operating requirements. The number of available "normal memory" channels (simplex or normal repeater offset memories) depends upon your Odd Split memory channel requirements. The greater the number of Odd Split memories required the fewer the number of available "normal memory" channels, and vice-versa. The maximum number of normal memory channels available varies from a high of 64 (no Odd Split memory channels) to zero when the set has been programmed for a total of 50 Odd Split memory channels. The chart below lists the relationship of normal to Odd Split memory channels.

Number of Odd Split channels per band	Total number of Odd Split channels available	Number of normal channels available (Split between the UHF and VHF bands)	Maximum number of memory channels available.
0	0	64	64
5	10	50	60
10	20	38	58
15	30	26	56
20	40	14	54
25	50	0	50

Reconfiguring Memory

The factory default for memory allocations is shown in the chart below:

Factory Default	VHF BAND	UHF BAND
Number of Odd Split Memories	25	25
Number of Normal Memories	0	0

The factory default allows the maximum number of Odd Split memory channels. Most users will want to reconfigure the memory allocation to more closely match their own operating requirements.

○ Function selection

1. Press the VFO key.
2. Turn the POWER switch OFF.
3. Press and hold the F and the MR keys and then turn on the POWER switch. The current split channel memory allocation will be displayed. The chart at the beginning of this section shows that by selecting different Split memory allocations you can determine the number of normal channels that will be available.

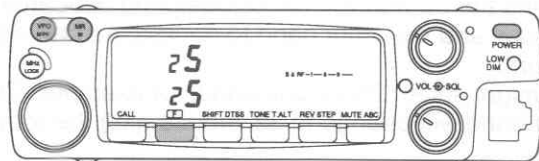

- Set the maximum number of split memory channels you want for each band by turning the tuning control. You will be able to select the Odd Split memory allocation in steps of 5.*
- Press the MR key. A second set of numbers will appear in the display. This second set up numbers is used to select the way the total number of memory channels is divided between the two bands. For example we might have selected 5 Odd split memories per band in step 4. This would mean that we have 60 total memory channels available. The second set of numbers in the display would be 30 for VHF and 30 for UHF.

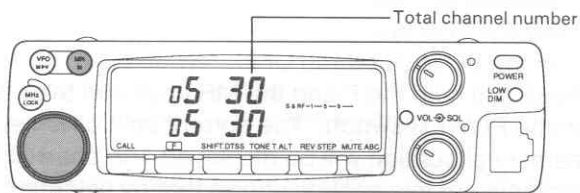

- Turn the main tuning control. The numbers in the total column of the display will increase/decrease. Turning the control will cause one band allocation to increase and the other band to decrease by an equal amount. You might select 28 for one band, for example. The other band will change to 32, maintaining the total at 60.

- The minimum number of channels you can select for a particular band will never be less than the number of Odd Split memory channels you have selected in step 4. Using the example above we could not select less than 5 memory channels for either band.
- Once the desired values have been reached you should press the MR key to store the data into memory, and return to the normal frequency display.

* The only exception to the 5 channel step size is when you have selected the maximum number of Odd Split channels.

Steps 5, 6, and 7 will enable you to reconfigure the Odd split memory channels in 1 step increments. Both memory channel programming indicators will show the same value when setting this channels configuration. For example:

Split Memory Channels	Total Memory Channels
44	44
06	06
43	43
07	07

You will note that both displays change to reflect the change in total and split memory allocations in this circumstance.

Notes:

1. Changing the memory allocation will erase all operator programmed memory, except for memory channel 1 on each band.
2. The split channels are allocated after the simplex channels the simplex channels for that band. For example, if there are 5 odd split channels and 25 normal channels, channels 26 to30 are split channels.

2. Microprocessor Memory Back-up

A lithium battery is contained in this transceiver to retain memory. Turning off the POWER switch, disconnecting the power cable or an intermittent power failure will not erase the memories. The battery life is estimated at 5 years. When the battery has been exhausted erroneous information might appear in the display.

Lithium battery replacement should be performed by an authorized KENWOOD service facility, or your authorized KENWOOD dealer. This equipment contains CMOS circuitry and can be damaged by improper replacement procedures.

3. Microprocessor Defaults

	144MHz	440/430MHz
VFO,Call channel and Memory channel 1 frequency	144.000 MHz	440.000MHz/430.000MHz
Frequency step	5kHz 12.5kHz (E, M type only)	25kHz
Tone frequency	88.5Hz	88.5Hz 1750Hz (E type only)

4. Memory Contents

Each Memory channel is capable of storing the following information;

	Normal channel	Odd Split channel
RX Frequency	○	○
TX Frequency(※)	NA	○
Tone (CTCSS) Frequency (With the optional CTCSS unit TSU-7)	○	○
Tone (CTCSS) status	○	○
Frequency step	○	○
Shift status (※)	○	NA
REV status (※)	○	NA
DTSS code , DTSS status	○	○

○: Can be stored in Memory.

NA: Cannot be stored in Memory.

(※) When a separate TX frequency is entered in a memory, the shift state and reverse on/off programming is removed from the memory.

5. RESET

5-1. Memory Reset

All user programmed data will be reset to factory defaults.

1. Turn the Power switch off.
2. Press and hold the MR key and turn on the POWER switch. Hold the key down until all the LCD indicators light.
3. Release the MR key.

5-2. VFO Reset

The microprocessor's VFO memory (excludes memory channels, CALL channel, and paging memory channel) will be reset to factory defaults.

1. Turn the Power switch off.
2. Press and hold the VFO key and turn on the POWER switch. Hold the key down until the normal display appears (approximately 1 second).
3. Release the VFO key.

○ VFO reset of one band only

Reset all data except the call channel, memory channel, paging code, and functions (such as LOCK, BEEP) common to the other bands.

1. Turn the POWER switch off.
2. Hold down the VFO key and the BAND SEL key for the band to be reset, then turn on the POWER switch. Hold the key down until the normal display appears (approximately 1 second).
3. Release the VFO key and BAND SEL keys.

6. Rewriting Call Channel Data

1. Press the BAND SEL key for the desired band.
2. Select the desired Call channel frequency, tone data, etc.
3. Press the F key momentarily. The F indicator will light and the memory channel indicator will light.
4. Press the CALL key within 10 seconds of pressing the F key to enter the data into memory. A long beep will sound and the F indicator and memory channel indicators will turn off to confirm data entry.

Split data can be stored in call channel

5. To store split data in call channel, press the CALL key for at least a second in step 4. The - and + indicators light.
6. Select the transmit frequency with the tuning control or microphone UP/DWN key.
7. Press the CALL key.

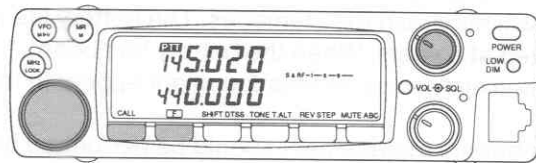

7. Changing Data Stored in Memory

Two methods have been provided to alter the contents of a memory channel.

- Entering new data into a memory channel will erase the old data. (See page 25 for details on entering data.)

Note

Entering new receive data in an odd split memory channel will erase the previous transmit frequency also. It will be necessary to enter both frequencies if you wish to keep that channel as an odd split memory channel.

- Clearing an individual memory channel
 1. Press the BAND SEL key for the desired band.
 2. Press the MR key.
 3. Select the memory channel that you wish to clear.
 4. Press and hold the F key and then press the MR key.

Note

The contents of memory channel number 1 cannot be cleared with this procedure.

8. Memory Shift

Using this function you can copy the contents of a memory channel or call channel to the VFO without changing the data in memory. This will allow you to begin tuning at the point specified by the memory channel data.

1. Select the desired Memory Channel.
2. Press the F key.
3. Within 10 seconds of pressing the F key press the VFO/M▶V key to copy the data.

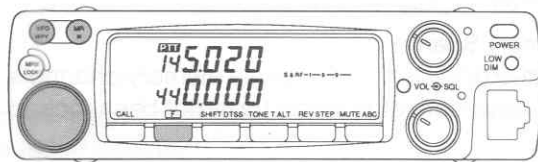

Note

Only the receive frequency data in the odd split memory channels is copied to the VFO.

■ SCAN

Each band can be scanned independently. For proper scan operation the squelch must be adjusted to the threshold point. Scan can not be used in conjunction with the Tone Alert function.

The following scan options are available:

- Band Scan
Scan proceeds over the entire band.
- Programmable Band Scan
The scan range in this mode is specified in memory .
- Memory Scan
Scan proceeds through those memory channels that have data stored and have not been locked out.
- CALL / VFO Scan
Alternate scanning of the call channel and the VFO.
- CALL / Memory Scan
Alternate scanning of the call channel and the memory channel that was last used.
- MHz Scan
Scans over a 1 MHz range.

1. Band Scan

1. Press the BAND SEL key to select the desired band
2. Adjust the SQL control of the band to the threshold point.
3. Hold down the VFO key for longer than 1 second (for the VFO mode).

The MHz indicator will begin blinking, and scan will begin.

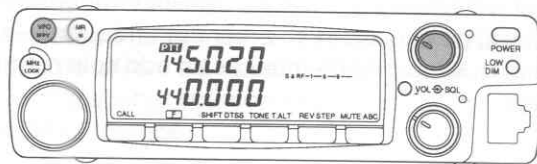

4. Scan will begin in an upwards direction. You can reverse the direction of scan by turning the Tuning control or pressing the microphone UP/DWN keys. The tuning step size depends upon the current Frequency Step selection.
5. Scan will stop on a busy channel, i.e. a station that is strong enough to open the squelch and turn on the BUSY indicator.
6. Press the microphone PTT switch or any other key . Scan will then stop.
7. You can scan both bands at the same time by repeating step 1 to 6 for the other band. Scan will stop only on the band(s) that receive a signal. The other band(s) will continue to scan.

2. Programmable Band Scan

The lower- and upper frequency limits are set in advance for each band.

● Lower and the Upper Scan Limit Entry

1. Hold down the F key, then press the MHz key.
L appears on the memory channel display.
2. Select the lower frequency limit with the tuning control, then press the MR key.
U appears on the memory channel display.
3. Select the upper frequency limit with the tuning control, then press the MR key.

To display the upper and lower frequency limit :

1. Hold down the F key, then press the VFO key.
The lower frequency limit is displayed.
2. Turn the tuning control until a click is heard.
The upper frequency limit is displayed.
The normal frequency display will return after pressing any key or after a 10 second delay.

● Operation

1. Press the BAND SEL key to select the desired band.
2. Adjust the SQL control to the threshold point.
3. Select a frequency between the two programmed scan limits.
4. Press the VFO key for longer than 1 second. The MHz indicator will begin flashing as a visual reminder the transceiver is scanning.
5. Press the PTT switch or any other key to stop scanning.

3. Memory Channel Scan

1. Press the BAND SEL key to select the desired band.
2. Adjust the SQL control to the threshold point.
3. Press the MR key for longer than 1 second to initiate memory scan of the band.

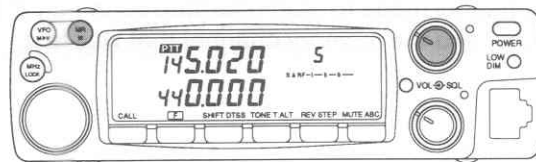

4. Scan will begin in an upwards direction. You can reverse the direction of scan by turning the Tuning control or pressing the microphone UP/DWN keys.
5. Scan will stop on a busy channel, i.e. a station that is strong enough to open the squelch and turn on the BUSY indicator.

NOTE

1. Only those memory channels that have data entered, and that have not been locked out it will be scanned.
2. Scan does not start unless there are 2 channels that have data entered.

4. CALL Scan

CALL / VFO Scan

Press the CALL key for longer than 1 second in the VFO mode to start alternate scanning of the VFO frequency shown on the display and the call channel.

CALL / Memory Channel Scan

Press the CALL key for longer than 1 second in the memory channel mode to start alternate scanning of the call channel and the memory channel that was last used.

5. MHz Scan

1. Press the BAND SEL key to select the desired band.
2. Adjust the SQL control to the threshold point.
3. Start the band scan or programmable band scan.
4. Press the MHz key during band scan or programmable band scan.

When the MHz key is pressed the MHz scan is executed.

Example: If the MHz key is pressed when the frequency is 145.02 MHz for VHF band scan, just the 145 MHz band is scanned.

6. Hold / Resume Programming

Two types of scan hold/resume have been provided in this transceiver. The scan hold/resume can be set for each band.

Time Operated Scan (TO)

In this mode the radio stops on a busy channel, remains there approximately 5 seconds, and then continues to scan even if the signal is still present.

Carrier Operated Scan (CO)

In this mode the radio will stop scanning on a busy channel and remain there until the signal drops out. The radio allows a 2 second delay before it resumes scanning so that you don't lose the station when operators change.

NOTES

1. When the CTCSS is operating, scan will stop only on a signal which contains the proper CTCSS tone.
2. With the DTSS is operation, scan will stop (with squelch turned off) whenever it receives a signal. Squelch will not open, however, until the proper DTSS signal is received.
3. With both the CTCSS and the DTSS are turned on scanning will stop when the proper CTCSS tone is received. Squelch will open only if the DTSS signal matches when scan stops.

The factory default is the Time Operated Scan mode. To switch between the modes use the following procedure.

● Hold/Resume selection

1. Press the BAND SEL key to select the desired band.
2. Press the F key for longer than 1 second. The F indicator will flash.
3. While the indicator is flashing press the VFO key. This will switch the Hold / Resume mode to the Carrier Operated mode and the CO indicator will light.

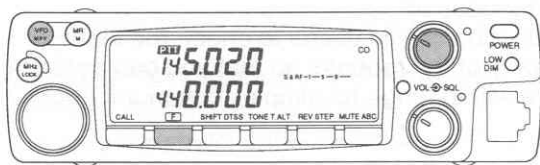

To return to Time Operated mode repeat steps 1, 2 and 3.

7. Memory Channel Lockout

This function allows you to specify which memory channels you wish to skip during memory channel scan.

1. Press the BAND SEL key to select the desired band.
2. Press the MR key to select the memory channel mode.
3. Select the memory channel that you wish to skip by turning the Tuning control or pressing the microphone UP/DWN keys.
4. Press the F key for longer than 1 second. The F indicator will begin to flash. Within 10 seconds of pressing the F key press the MR key. A ★ indicator will appear to the left of the memory channel number. This indicates the memory channel will be skipped during the memory channel scan.

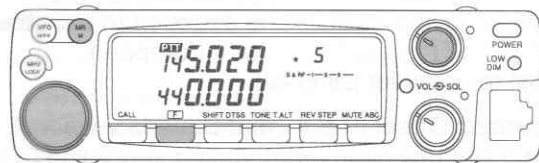

5. Repeat steps 2, 3 and 4 to lock out any other channels you wish to skip.
6. To cancel the lockout, select the desired memory channel as described in steps 1, 2, 3 and 4 above. A ★ indicator should appear to the left of the memory channel number. Press the F key for longer than 1 second and then press the MR key. The ★ indicator should turn off.

REPEATER OPERATION

1. Transmitter Offset

All amateur radio repeaters use a separate receive and transmit frequency. The receive frequency may be above or below the transmit frequency. The configuration of most repeaters fall into one of the categories listed below:

	144 MHz band	TM-732A 440/430 MHz band	TM-732E 430 MHz band
+	+600 kHz	+5 MHz	+1.6 MHz
-	-600 kHz	-5 MHz	-1.6 MHz
--		-	-7.6 MHz

● Offset Direction

To select the desired transmitter offset direction press the SHIFT key. Each time you press the key the transceiver advances from one direction to the other, i.e. "+" to "-" ("-" to "--" with European versions) to no offset (simplex).

● Automatic Offset (U.S.A., and Canada versions)

The TM-732A has been programmed according to the standard ARRL (Amateur Radio Relay League) Band Plan with regard to transmitter offset direction. See the accompanying chart for additional information about this programming. You can, of course, override this by using the SHIFT key if desired.

145.1 145.5 146.0 146.4 146.6 147.0 147.4 147.6 148.0

S	-	S	+	S	-	+	S	-	S
---	---	---	---	---	---	---	---	---	---

S : simplex

2. Reverse Function

Some repeaters use a "Reverse Pair", i.e. the transmit / receive frequencies are the reverse of other repeaters. For example, repeater A uses 146.000 for a transmit frequency (INPUT) and 146.600 for a receive frequency (OUTPUT). Repeater B might use 146.600 for a transmit frequency and 146.000 for a receive frequency. It would be inconvenient to have to reprogram the transceiver each time you wanted to use these repeaters.

The REV key allows you to easily reverse the transmit and receive frequencies. To use the REV function press the REV key. The R indicator goes on on the display to indicate that you are working a reverse pair. To return to normal press the REV key again. The R indicator goes off.

This function is also useful to check the input frequency of the repeater so that you can determine if you are within range for simplex communications.

3. Tone Operation

Some repeaters require the use of a control signal to activate the repeater. Several different methods are currently in use. In the United States sub-audible tones are sometimes used, 38 different sub-audible frequencies being possible. In EUROPE and UNITED KINGDOM a 1750 Hz tone is used to access the repeater. Press and hold the Microphone 1750 key to transmit with the access tone. You need not press the PTT switch. (MC-45E)

● Tone Frequency Selection

Each band can have different the Tone Frequencies.

1. Press the F key for longer than 1 second. The F indicator will flash. Press the TONE key. The current tone frequency will appear in the display.

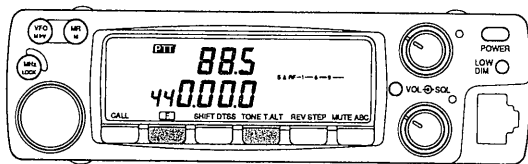

2. Rotate the Tuning control or press the microphone UP/DWN key to select the desired tone frequency.
3. Press any front panel key or wait 10 seconds to return to the normal frequency display.

Tone Frequency (Hz)

67.0	82.5	97.4	114.8	136.5	162.2	192.8	233.6
71.9	85.4	100.0	118.8	141.3	167.9	203.5	241.8
74.4	88.5	103.5	123.0	146.2	173.8	210.7	250.3
77.0	91.5	107.2	127.3	151.4	179.9	218.1	
79.7	94.8	110.9	131.8	156.7	186.2	225.7	

● Tone Operation

Press the TONE key and select the desired Tone mode. When the T indicator appears in the display the transmitter will transmit the desired tone. Tone signals can be transmitted.

When no Tone indicator is on, the radio will not make use of either tone feature.

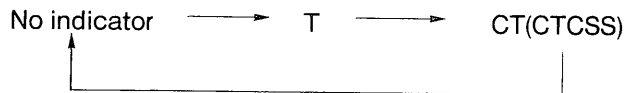

4. Autopatch Operations (U.S.A. version only)

Some repeaters offer a service known as autopatch. This feature allows you to dial a telephone number from your transceiver and carry out a telephone conversation, much like a car telephone, or cellular telephone. This function requires the use of a DTMF (Dual Tone Multi Frequency) pad. The DTMF microphone provides the normal keys you would have on your telephone at home, in addition to the normal 12 keys that are found on your telephone as well as 4 additional keys, A, B, C and D. These keys are required by some repeater systems for various functions. Ask the control operator of your repeater to determine if their use is required. A chart is provided that lists the various tone frequencies that are generated by the keypad.

(Fig.1)

To activate the keypad:

1. Press and hold the PTT switch.
2. Press the keys just like you would dial your telephone at home.
3. The transceiver will remain keyed for approximately 2 seconds after you press each number, so you can release the PTT switch without unkeying the transceiver.

NOTE

Some repeaters will require the use of a special key sequence to activate the autopatch function. You should check with your control operator for this sequence.

(Hz)	1209	1336	1477	1633
697	1	2	3	A
770	4	5	6	B
852	7	8	9	C
941	*	0	#	D

FIG.1

5. DTMF Memory

Up to 10 DTMF numbers (up to 15 digits) can be put into memory.

●How to store DTMF signals

1. Press and hold down the F and CALL keys, then switch the power ON.

P --- appears in the display.

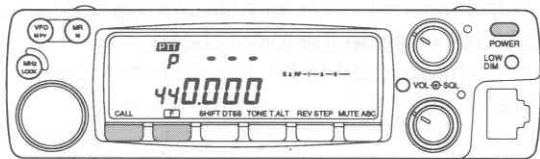

2. Press the desired DTMF key. (Up to 15 digits)

- The number is displayed from the right; when more than four digits are displayed, the first digit scrolls to the left.

- If you press the wrong key, press the microphone VFO key, and start over.

3. After the number has been entered, press the microphone PF key.

- The display changes to P ---.

A close-up of the radio's digital display. It shows 'P' in a small box on the left, followed by a hyphen and the number '020'. The digits are large and clear.

4. Press a numeric key from 0 to 9 for the DTMF memory channel that you want the number to be stored in.

5. To cancel the setting, press PTT.

●To check the memory contents before transmission:

1. Press and hold down the F and CALL keys, then switch the power on.
2. Press the microphone MR key.
3. Press the numeric key (0 to 9) that corresponds to the DTMF memory channel that you want to checked.

- The numbers stored in memory are displayed sequentially in the frequency display, while the DTMF tones sound.

4. After the number has been displayed the radio will return to the position shown in the diagram at the left.

To cancel the setting, press PTT.

●Transmitting DTMF memory contents.

1. Press the BAND SEL key to select the desired band.
2. Select the transmit frequency with the tuning control or the microphone UP or DWN key.
3. Press and hold the PTT switch, then press the microphone PF key.
 - The P indicator lights, and the receive mode returns automatically. Release the PTT key.
4. Select the desired DTMF memory channel number with the numeric keypad (0 to 9).

The transmit mode is entered, and the DTMF memory channel contents are transmitted. When transmission ends, the receive mode returns automatically.

■ OTHER USEFUL FUNCTIONS

1. Dimmer (DIM)

The intensity of the display illumination can be set to one of four levels (d1 thru d4, with d1 being the brightest.) or off. (default is d2.)

1. Press the F key, then press the LOW/DIM key while the F indicator is lit. The display will show which intensity level is currently in use.

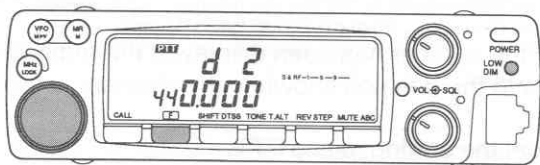

2. Select the desired value (d1 to d4) with the tuning control or the UP/DWN key on the microphone.
3. To return to the normal frequency display press any key or wait 10 seconds.

- The display intensity can be made one step brighter for five seconds when you press a key or turn the tuning control.

If you select d1, this function does not work.

1. Turn the POWER switch off.
2. Press and hold the F and LOW/DIM key, and turn on the POWER switch.

Note
When the power is switched on, the display intensity decreases 2 steps to extend the life of the lamp.

2. Beep Tone Level Adjustment

The beep can be set to one of eight levels (off to b7). (default is b5.)

1. Press the F key for longer than a second, then press the REV key while the F indicator is flashing. The display will show which beep level is currently in use.
2. Select the desired value with the tuning control or the UP/DWN key on the microphone.
When the beep is set to b7, the maximum beep sounds.

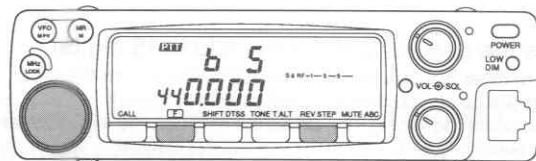

3. To return to the normal frequency display press any key or wait 10 seconds.

3. Clearing the Unused Band Display

You can clear the unused band from the display. Transmit and receive is not possible if you turn the band display off.

1. Press the F key for longer than one second.
2. Press the BAND SEL key corresponding to the band to be cleared while the F indicator is flashing.
 - — OFF — appears on the specified band display for 10 seconds, and the specified band is no longer displayed.
 - When the power switch is turned on, — OFF — will be displayed for 10 seconds, then disappears.

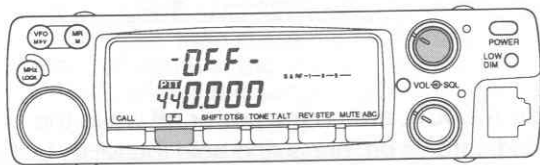

To enable the band again, repeat steps 1 and 2.

4. Automatic Power Off (APO)

This transceiver also provides an Automatic Power off circuit. The circuit action is described below. (default is off.)

1. To turn the APO function on/off, press the F key for longer than 1 second and then press the MHz key. The APO indicator lights.

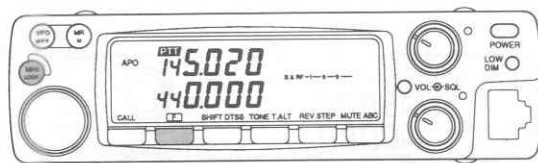

A 5 second audio confirmation tone will sound after 2 hours 59 minutes if no signal has been received and if you have not performed any operation.

1 minute after this alert signal the transceiver will shut itself off.

2. When the APO operates and the transceiver is shut off, the transceiver can be reactivated by turning the POWER switch back on.

5. Key Locks

LOCK

When this function has been activated all the front panel keys and the Tuning control are disabled.

Function selection

The microphone keys work, however.

Press the F key, then press the MHz/LOCK key within 10 seconds. The LOCK indicator lights.

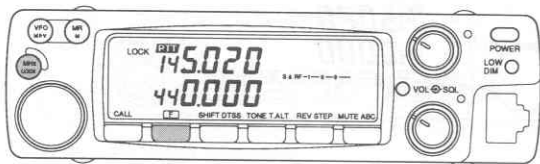

To release the lock, press the F key again, then press the MHz/LOCK key within 10 seconds.

ALL LOCK

All operations, except for power ON/OFF control, volume, and squelch, are disabled.

Function selection

Switch the power off while the LOCK indicator is on, hold down the MHz/LOCK key, and switch the power on again. The A.LOCK indicator lights.

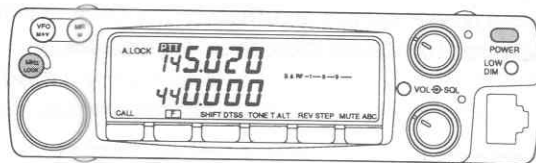

To release A.LOCK, switch the power off while the A.LOCK indicator is on, press and hold the MHz/LOCK key, and switch the power on again. The A.LOCK operation cannot be canceled by VFO reset or MR reset.

Electronic tone for A.LOCK

When the microphone PTT, CALL, VFO, MR, UP, DWN, or PF key is pressed during A.LOCK operation, the tone corresponding to each key is output from the speaker.

6. Programmable VFO Tuning Limits

This radio provides the capability of programming the VFO tuning range, in 1 MHz band segments, as well as providing a separate programmable band scan function. (See page 41.)

The procedure for specifying the bands is described below.

1. Press the BAND SEL key to select the desired band.
2. Rotate the Tuning control until the desired lower tuning range appears on the frequency display.
For example, you might want to select the 438 MHz band and dial up 438.100 MHz.
3. Press and hold the F key, then press the CALL key.
4. Rotate the Tuning control until the desired upper tuning range appears on the frequency display.
5. Press and hold the F key, then press the SHIFT key.

To cancel the programmable VFO function for each band, switch the power off, hold down the VFO key and the VOL control for that band, then switch the power on.

To cancel the programmable VFO function for both bands, switch the power off, and hold down the VFO key, and switch the power on.

7. Frequency Step Selection

To select the desired tuning or scan step size use the following procedure:

1. Press the BAND SEL key to select the desired band.
2. Press the F key momentarily. The F indicator should light on the display.
3. Press the REV/STEP key within 10 seconds of pressing the F key. The current frequency step size will be displayed.
4. Rotate the Tuning control or press the microphone UP/DWN keys until the desired tuning step size appears in the display.
5. To complete the programming of the step size you can press any front panel key or simply wait 10 seconds and the microprocessor will automatically return to the normal frequency display.

The chart below illustrates the way the displayed frequency will change when you change from one step size to another.

5,10,15,20 to 12.5,25

0, 5, 10, 15	0
20, 25, 30, 35	25
40, 45, 50, 55	50
60, 65, 70, 75, 80, 85, 90, 95	75

For example:

Assume you are presently displaying a frequency of 439.920 MHz and had previously selected a 20 kHz step size. If you were to change the step size to 12.5 kHz the display would then read 439.925 MHz.

12.5,25 to 5,10,15,20

0	0
12.5	10
25	20
37.5	30
50	50
62.5	60
75	70
87.5	80

8. Beep Tone Frequencies

- Reprogramming the function of the microphone PF key.

1. Turn the POWER switch OFF.
2. Press and hold the F key and the TONE key then turn the POWER switch ON.
3. Release the F key and the TONE key.

● Operation

The chart below lists the tone frequency assigned to the various display characters.

0	523.248Hz	C	5	880.000Hz	A
1	587.328Hz	D	6	987.770Hz	B
2	659.248Hz	E	7	1046.496Hz	C
3	698.464Hz	F	8	1174.656Hz	D
4	783.984Hz	G	9	1318.496Hz	E

Pressing the microphone PF key while a frequency is displayed will cause the radio transmit a series of tones that correspond to the display frequency.

9. Channelized Frequency Display

The frequency display can be changed to display channel numbers instead of the operating frequency. This function makes use of the data you have stored in memory for this function. Channel 1 is memory channel 1, Channel 2 is memory channel 2, etc.

1. Turn the POWER switch off.
2. Press and hold down the REV key, then press the POWER switch.

Channel number are displayed for both bands, and the U indicator lights for the UHF band.



3. The channel number can be changed with the tuning control or microphone UP/DWN key when the BAND SEL key for the desired band is pressed.

To return to the normal frequency display, perform steps 1 and 2 again.

Functions that operate when using the channel number display

Press the key momentarily. The bold function will be executed	Press the key for longer than one second.	Press the F key for longer than one second, then press below the listed key.	Hold down the F key, then press the below listed key.
MR/M	MR/M: Memory scan	VFO/M▶V: Scan restart condition setting	REV/STEP: Automatic paging cancel
CALL	CALL: Call scan	MR/M: Memory channel lockout	Hold down one of the following keys, then switch the power on.
F	Press the F key, then the below listed a key within 10 seconds.	SHIFT/DTSS: DTSS code setting/Paging code setting	SHIFT/DTSS: Delay time selection
SHIFT/DTSS		TONE/T.ALT: Tone frequency selection	Hold down the F key and one of the following keys, then switch the power on.
TONE/T.ALT	MHz/LOCK: Key lock	LOW/DIM: S meter squelch selection	SHIFT/DTSS: Tone alert selection
REV/STEP	SHIFT/DTSS: DTSS/paging setting	BAND SEL V: Display on/off	LOW/DIM: The illumination can be made brighter by one step
MUTE/ABC	MUTE/ABC: Automatic band change setting	BAND SEL U: Display on/off	
LOW/DIM	LOW/DIM: Illumination brightness selection		
C.SEL	C.SEL: Receive two signals on the same band at the same time.		
BAND SEL V			
BAND SEL U			
Tuning control			

10. Pushbutton Control Using the DTMF Microphone

This transceiver can be controlled by the DTMF tones generated by the DTMF microphone. (The MC-45DM microphone is optional in some market areas.)

● Function selection

Hold down the F key, then press the C. SEL key.

The S/RF indicator flashes.

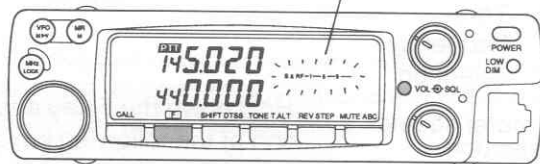

● Operation

1. Connect the DTMF microphone.
2. The functions that can be controlled by the microphone and the associated key are listed in the accompanying chart.

To cancel DTMF microphone control press and hold the F key and then press the C.SEL key.

MC-45DM key	Key operation	MIC1 key (F key) operation + key
1	Same as SHIFT on the transceiver	Bell sound selection
2	Same as TONE on the transceiver	Tone frequency selection
3	Same as REV on the transceiver	Shift selection
4	Same as MHz on the transceiver	—
5	Monitor key	Microphone key lock setting
6	Indicate frequency by tone.	Microphone key lock cancel
7	VOL UP/DWN ON/OFF	—
8	Change between UxU and VxV.	—
9	SQL UP/DWN ON/OFF	—
0	Same as LOW on the transceiver	Change the illumination brightness.
A	Enter key	—
B	Same as C.SEL on the transceiver	Speaker change
C	Same as MUTE on the transceiver	—
D	Same as F on the transceiver	F key operation off
* (star)	DOWN key	DOWN key
# (hash)	UP key	UP key

Operation

Example 1: Change transmitter power output with the DTMF Microphone.

1. Press the microphone 0 key.
Each time the 0 key is pressed, transmit power output changes from high to medium to low and back to high.

Operation

Example 2: Change the volume with the DTMF Microphone.

1. Press the microphone 7 key.
2. Select the desired volume with the microphone UP/DWN key.

Operation

Example 3: Change the display lamp intensity.

1. Press the microphone D key.
2. Press the microphone 0 key.
3. Adjust the brightness with the # and * keys.

11. Remote Control by External DTMF Signal

This transceiver can be controlled by another transceiver that can transmit DTMF signals.

1. See "DTSS code selection" on pages 61 and 62, and set the DTSS code. This code is used as a control password to prevent unauthorized changes.
2. Cancel the DTSS mode.
3. Specify the band to be controlled and the frequency for receiving the external control signals. The control select LED lights for the controlled band.

Example: The band to be controlled is the VHF band and the frequency for receiving external control signals is 438.640 MHz.

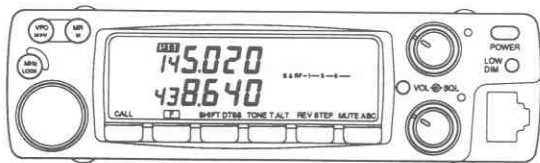

4. Turn the POWER switch off.
5. Hold down the C. SEL key, then press the POWER switch.
 - The DT and S&RF indicators flash. The transceiver now waits for an external control signal.
 - The transceiver is locked, and does not accept any front panel key input when operating in this mode.

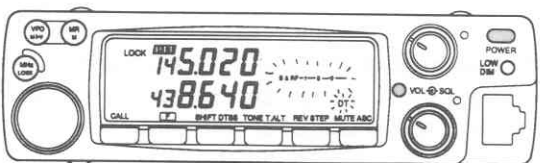

6. Set the frequency of the remote transceiver that can output DTMF signals in the 430MHz band to 438.640 MHz.
7. The remote transceiver should be placed in transmit, and the operator should send " A " followed by the correct DTSS code, then " # ". This will cause the DT indicator on the display to turn off. The radio is now ready to accept the external control signal.
8. The following functions may be controlled by the remote station.

DTMF key	Control function
1	Enables the T.ALT function.
2	Enables the tone.
3	Enables the tone squelch.
4	Disables the T.ALT function.
5	Disables the tone.
6	Disables the tone squelch.
7	Call channel
8	VFO mode
9	Memory channel
0	Switch transmission output.
A	The enter mode is set, and the frequency can be set with keys 0 to 9.
B	Tone frequency selection mode

DTMF key	Control function
C	To turn Repeater Cross-Band on
D	To turn the Repeater Cross-Band off
✳	Same as DOWN key
#	Same as UP key

9. The remote operator should terminate the control function by sending "A" "#". This will turn the DT indicator back on and allow the radio to resume normal operation.

CAUTION :

It is illegal to transmit control codes on the 2 m band. You can only transmit the control codes on the 70 cm band. (U.S.A. version only)

Examples

- Set the frequency to 145.320 MHz.
Enter "A" "4(K, P type only)" "5" "3" "2" "0" with the DTMF keys.
- Select to memory channel mode
Press DTMF key 9.
The transceiver enters the memory channel mode.
Select a memory channel by pressing the DTMF "#" key (same as the UP key) and "*" (same as the DOWN key).

- Select the tone frequency.
Press DTMF key "B" "A", then press the appropriate CH. NO. key as given in the table on page 59.
To set 100.0 Hz for the tone frequency, enter "1" "2".

The Repeater Cross-Band mode can be turned ON/OFF with external DTMF commands as follows. This will allow you to remotely change the operating frequency of the controlled band.

- To turn Repeater Cross-Band on
 1. Access the TM-732A by sending "A", the DTSS code, and then "#".
 2. Then send the C command.
 3. Then send the "A" and "#" command.
- To turn the Repeater Cross-Band off
 1. Send "A", the DTSS code, and then "#".
 2. Then send the "D" command.

To cancel the function:

1. Transmit "A" "#" from the remote transceiver to return to step 4.
2. Hold down the F key, then press the MHz key within 10 seconds. (Lock release) (On the local unit)
3. Turn the POWER switch off.
4. Hold down the C. SEL key, and press the POWER switch.

12. Operation as a Repeater (U.S.A., CANADA versions only)

This transceiver is capable of operating as a repeater. There are two different repeater modes possible:

● Cross-Band Repeat Mode

The transceiver listens on both bands simultaneously. As soon as a signal is received on one band, the other shifts from receive to transmit and re-transmits the incoming signal.

1. Select the operating frequencies and adjust the squelch controls to threshold.
2. You may want to set the Time-Out Timer to 3 minutes to protect the transmitter.
3. Press the BAND SEL key of one band and then press the C.SEL key to select the other band.
4. To turn the REPEATER CROSS-BAND function on or off, press the F key for longer than one second and then press the MUTE/ABC key. Three dots(.) will light in the display.

● Fixed Band Repeat Mode

This is a one way repeat operation. One band is dedicated to transmit and the other band is dedicated to receive.

1. Repeat the steps listed above, but do not press the C.SEL key. The band dedicated to transmit is selected with the BAND SEL key.

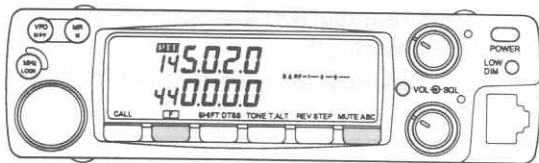

Notes

1. Combinations of SHIFT and CTCSS can be used in the Repeater Cross-Band mode. DTSS and PAGING will not work in this mode.
2. You must select Cross Band Repeat or Fixed Band Repeat before using Remote Control function.

CAUTION

This equipment can be extremely susceptible to lightning strike damage or intermodulation distortion if it is operated on mountain top locations.

Hang Time Selection

The amount of time that the transceiver will remain keyed after the incoming signal has dropped out is known as the Hang time. This prevents the repeater function from returning to receive on momentary signal dropouts. The factory default is 500ms. You can turn the function OFF using the following procedure:

First make sure the radio is in the repeater mode. Press and hold the F key for longer than one second, then within 10 seconds press the CALL key. To switch back to 500 ms repeat this procedure.

SECTION 3 Communicating with an other station

1. CTCSS Operation

When the CTCSS function has been activated the radio will not open squelch until the proper tone is received. This function is effective only when the optional TSU-7 is installed.

1-1. Tone Frequency Selection

The tone frequency can be set for each band.

1. Press the BAND SEL key to select the desired band.
2. Press and hold the F key for longer than one second. The F indicator begins to flash.
3. Press the TONE key while the F indicator is flashing (10 seconds).
 - A tone frequency is displayed.

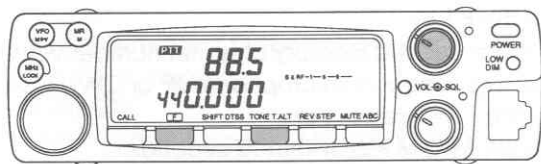

4. Select the displayed tone frequency with the tuning control or microphone UP/DOWN key.

To return to the normal frequency display, press any front panel key, or wait 10 seconds.

There are 38 possible tone frequencies.
Factory default: 88.5 Hz

CH. NO	(Hz)	CH. NO	(Hz)	CH. NO	(Hz)	CH. NO	(Hz)
1	67.0	6	82.5	11	97.4	16	114.8
2	71.9	7	85.4	12	100.0	17	118.8
3	74.4	8	88.5	13	103.5	18	123.0
4	77.0	9	91.5	14	107.2	19	127.3
5	79.7	10	94.8	15	110.9	20	131.8

CH. NO	(Hz)	CH. NO	(Hz)	CH. NO	(Hz)	CH. NO	(Hz)
21	136.5	26	162.2	31	192.8	36	233.6
22	141.3	27	167.9	32	203.5	37	241.8
23	146.2	28	173.8	33	210.7	38	250.3
24	151.4	29	179.9	34	218.1		1750
25	156.7	30	186.2	35	225.7		

1-2. CTCSS Setting

1. Press the BAND SEL key to select the desired band.
2. Press the TONE key repeatedly until the CT indicator lights in the display. The indicator will alternate between T (for transmit encode tone only) to CT (for transmit and receive tone Tone Squelch.)

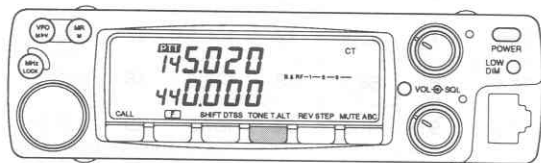

Use of noise squelch is recommended when using CTCSS.

1-3. Transmission

When the PTT switch is pressed, the selected tone frequency is transmitted along with the normal voice audio.

1-4. Tone Squelch Operation

The squelch opens only when the incoming tone frequency matches the preset CTCSS tone.

1-5. Entering the Data into Memory

The tone frequency and tone squelch status can be stored into memory with the normal transmit and receive data.

Entering data into memory

1. Press the F key.
2. Select the desired memory channel number with the tuning control or microphone UP or DWN key while the F indicator is on.
3. Press the MR/M key within 10 seconds.

Entering data into a call channel

1. Press the F key.
2. Press the CALL key while the F indicator is on.

2. DTSS(Dual Tone Squelch System)

2-1. Preparation for DTSS Operation

This function allows the squelch to be turned on in the receive mode on reception of a three-digit code matching the DTSS code selected in your radio. Once the squelch is turned on by reception of a matching code, it operates normally from then on. If no signal is received for longer than 2 seconds, the squelch is turned off until a matching code is received.

NOTE

This function is not available in some areas. The DTSS (or PAGING) code may not be accepted if the repeater is "identifying". If this should occur you should press the PTT switch again, and retransmit the DTSS (or PAGING) cord.

There are two recommended methods of compensating for this situation.

1. Press the PTT switch for a few seconds, send the DTSS (or PAGING) cord, release the PTT switch, then press the PTT switch again and resend the appropriate cord.
2. Proper DTSS (or PAGING) operation will occur if you ensure the battery saver circuit is disabled whenever you intend to operate using either the DTSS or PAGING modes.

2-2. DTSS Code

DTSS codes from 000 through 999 can be selected from the VFO mode and stored in memory channels and the CALL channel.

The initial DTSS Code selection is 000.

2-3. DTSS Code Selection

Change the DTSS code using the same procedure.

1. Press the BAND SEL key to select the desired band.
2. Press the F key. The F indicator lights.
3. Press the SHIFT/DTSS key while the F indicator is on (10 seconds).

This will cause the display to shift as shown in the diagram below. Continue pressing the SHIFT/DTSS key until the DT indicator appears in the display.



4. Press the F key for longer than 1 second and then press the SHIFT/DTSS key. The display will change to the DTSS code entry mode. (See example below.) The digit just to the left of the "0" will be flashing.

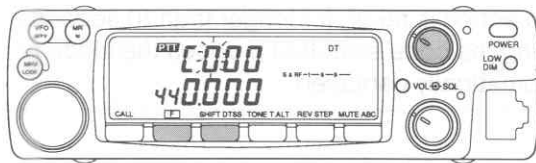

5. Select any digit from 0-9 by rotating the Tuning control, or by pressing the UP/DWN switches on the microphone, then press the SHIFT/DTSS key. (Or press the desired number on the microphone keypad. This will enter the number and advance you to the next number position without having to press the SHIFT/DTSS key again.).
6. After you select the first digit a beep will sound and the middle digit will begin flashing. Select the next number by using any of the methods described above.
7. Select the final digit as described above. After the last digit has been entered the display will return to the normal frequency mode, indicating the tone selection process has been successfully completed.

NOTES

1. If a key other than the DTSS key is pressed during the code selection process, the code selection mode is canceled.
2. If no action is taken for longer than 10 seconds during the code selection process the mode is automatically canceled.

2-4. Entering Data into Memory

It is useful to put frequently used DTSS codes and frequencies into memory. DTSS can then be used simply by recalling memory. Separate data can be put into each memory channel or call channel.

Entering data into memory

1. Press the F key.
2. Select a memory channel number with the tuning control or microphone UP or DWN key while the F indicator is on (10 seconds).
3. Press the MR/M key within 10 seconds.

Entering data into the call channel

1. Press the F key.
2. Press the CALL key while the F indicator is on (about 10 seconds).

2-5. Setting Delay Time

The DTSS signal is not transmitted immediately after you press the PTT switch. A programmable delay time has been incorporated to allow the DTSS signal to be passed by repeaters with slow response times. You can select a delay time of 350 mS or 550 mS.

When operating simplex mode a delay of 250mS will automatically be selected for you. No other choice is available in this mode, even though you may have selected a different delay.

In modes other than simplex you may select between the remaining delay periods (350 mS or 550 mS).

The delay time is the same for both bands.

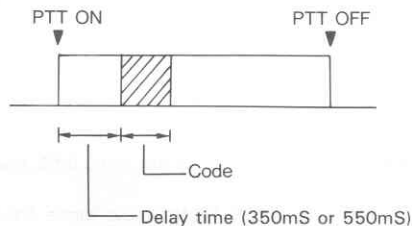

○ Changing the delay time to 550 ms.

1. Turn the POWER switch off.
2. Hold down the SHIFT/DTSS key, then press the POWER switch.
3. 350 (initial setting) appears in the frequency display for the operation band. Select 550 by turning the tuning control.

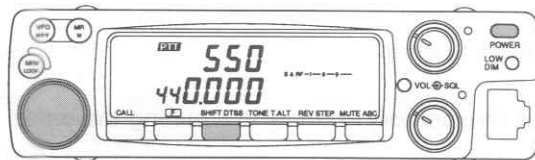

4. To return to the normal frequency display wait 10 seconds for automatic return, or press any key.

2-6 Using the DTSS Function

Press the BAND SEL key to select the desired band.

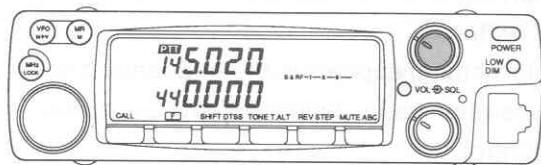

Memory channel

Call the memory channel containing the data.

Call channel

Press the CALL key.

VFO

Press the F key, then press the SHIFT/DTSS key within 10 seconds. The DT indicator lights.

Transmit operation

When the PTT switch is pressed on the microphone the selected code group will be transmitted. It will take about 1/2 second to transmit the 3 tones. The microphone will be muted while the tones are being transmitted.

Receive operation

The squelch will now remain closed until the correct code group is received.

When a signal matching the programmed code is received, the squelch opens. If no signal is received from the other transceiver for two seconds or more after the squelch turns on, the squelch turns off.

Use of noise squelch is recommended when using DTSS.

Notes

1. DTSS for two bands can be turned on at the same time, but the first signal may not be received.
2. If the receiving transceiver is in the battery save mode, the DTSS code may not be received. To be sure the signal is received, transmit it for several seconds, release the PTT key, and transmit again.
3. If S meter squelch is used, DTSS cannot be received if the signal is not stronger than the set level.

3. PAGING

The function is useful for net operations or for selectively calling an individual.

Example: When member 2 is called

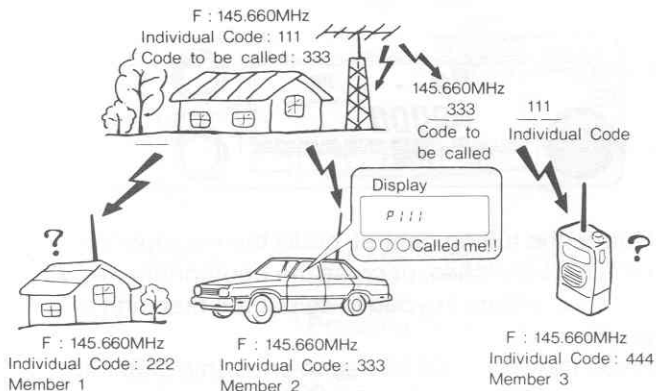

Normal operating procedure would require that you make prior arrangements with all members of the group/net, so that all interested parties know which DTMF code will be used for individual/group calls, and that everyone knows who uses which individual code. Since the paging system makes use of a 3 digit code (000 thru 999) you could have a very large group and still have extra code groups available. The paging function permits the 3 digit code of the calling station to be displayed in the display to allow easy identification of the calling station.

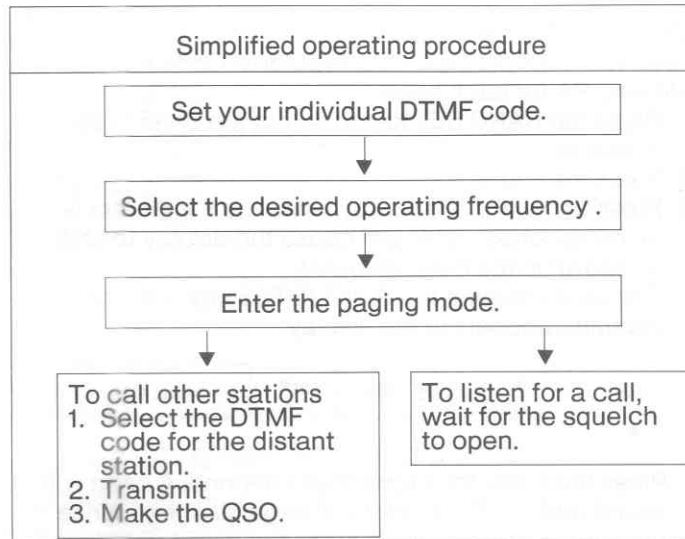

3-1. Paging Code Memories

Seven different paging code memories have been provided.

Paging Code Memory No.	Usage
PA	Stores your own station code.
P0	Automatically stores the calling station's code during receive. Can be used to temporarily store the code for the station to be called.
P1~P5	Stores group codes, and the codes of other stations.

3-2. Code Selection

First, you must program your Individual Code into Memory PA for each band.

1. Press the BAND SEL key to select the band to be operated.
2. Press the F key.
3. Press the SHIFT/DTSS key while the F indicator is on (10 seconds). This will cause the display to shift as shown in the diagram below. Continue pressing the SHIFT/DTSS key until the P indicator appears in the display.



4. Press the F key for longer than 1 second. A beep will sound and the F indicator will begin flashing. While the F indicator is flashing press the SHIFT/DTSS key. The display will change to the Paging Code Memory Channel Selection mode and the Paging Code Memory Channel indicator will begin flashing.

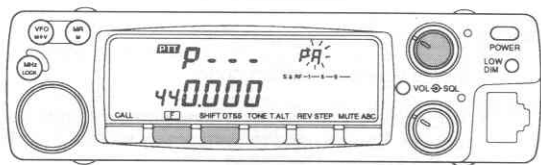

5. Select PA (your Individual Code) with the tuning control.

6. Press the SHIFT/DTSS key to complete the Paging Code Memory Channel Selection and enter the Paging Code Selection mode. The first digit to the right of the large "P" will begin flashing.

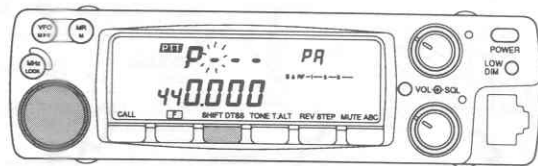

7. Rotate the tuning control, press the microphone UP/DWN switches, or press the appropriate key on the microphone keypad to select the first digit of the paging code.
8. Press the SHIFT/DTSS key to enter this digit into memory. The middle digit will then begin flashing.

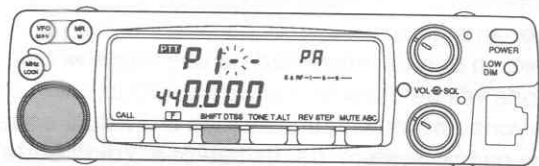

9. Repeat steps 7 and 8 to complete the programming of this particular paging code. After you enter the final digit of the code the display will return the Paging Code Selection mode.

3-4. Code Lockout

Codes are locked out only for receive during the Paging Mode.

It is possible to temporarily disable Paging Code Memories 1,2,3,4, and 5 during receive. This will allow you to more closely control which individuals, or groups can open your squelch at any given time.

Paging Code Memories 0 and A cannot be locked out. Locking out a particular code for receive will not prevent the code from being transmitted, should you select that particular Code Memory.

● Code Lockout

1. Perform steps 1 to 4 on page 66.
2. Select the Paging Code Memory Channel number you wish to lock out by using the tuning control or the microphone UP/DWN key.
3. Press the MR/M key.

A ★ will appear to the left of the Paging Code Memory Channel indicator to remind you that you have locked out this code memory for receive.

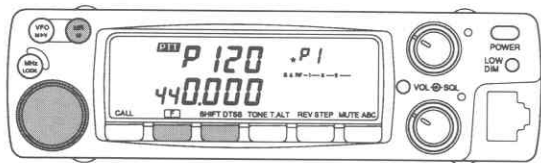

3. To restore the code memory for receive use repeat steps 1 thru 3 above.

3-5. Cancelling Signal Squelch

Squelch will not open when operating in the paging mode when the paging codes do not match. It is possible to reprogram the transceiver so that squelch will open regardless of the incoming page code. Signal type squelch can be cancelled for each band, if desired.

● Cancelling signal type squelch

1. Turn the POWER switch off.
2. Hold down the BAND SEL key for the band for which signaling squelch is to be canceled, then press the POWER switch.

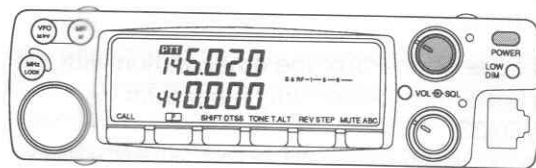

Even when signal squelch is canceled, a beep sounds and the individual code of the remote station is displayed when the proper code is received.

To return signal squelch to the original state, repeat steps 1 and 2.

For example, the following groups communicate with each other.

Predetermined frequency		145.660MHz
Your Individual code		111
Member 1	Individual code	222
Member 2	Individual code	333
Member 3	Individual code	444
Group code		789

Your memory
PA 111
P0
P1 222
P2 333
P3 444
P4
P5 789

Member 1
PA 222
P2 789

Member 2
PA 333
P3 789

Member 3
PA 444
P4 789

3-6. Code Transmission

Your station ID code should be programmed in Paging Code Memory Channel PA.

1. Select the desired operating frequency.
2. Press the SHIFT/DTSS key until the Paging mode indicator appears. (The Paging mode should be active on the other transceiver also!)
3. Press the F key for longer than 1 second and press the SHIFT/DTSS key. The Paging Mode Memory Channel Indicator will begin flashing.
4. Select the desired Paging Code Memory Channel with the tuning control or microphone UP/DWN key.
5. Press any key except the SHIFT/DTSS key to return to the frequency display.
6. Press the PTT switch. The selected transmit code will be transmitted along with your station ID code (the one stored in PA).

Notes

If the remote transceiver is in the battery save mode, the code may not be received. To be sure the code is received, transmit it for several seconds, release the PTT key, and transmit again.

3-7. Paging Code Monitoring

1. Select the desired operating frequency.
2. Press the DTSS key until the Paging Mode indicator appears in the display.
3. When the proper code is received, your squelch will open and you will hear an alert tone sequence coming from the speaker. The display will indicate the individual or group code of the calling station.

Stand by with individual code

If the calling station transmits your individual call the display will show Paging Mode Memory Channel 0, and will display the ID code of the calling station. (Example: Frequency: 145.660 MHz, calling station ID code is 144.)

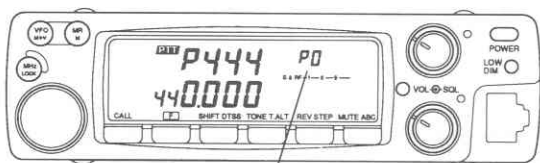

Zero is displayed to indicate your station is being called.

Stand by with group code.

If the calling station transmits the group code, the group code and the Paging Mode Memory Channel Number that contains that code will display. (Example : group code 789 is stored in Paging Mode Memory Channel 5.)

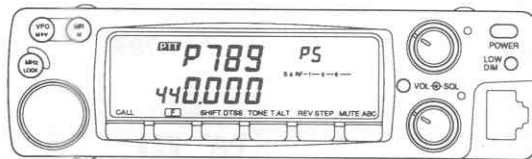

This Paging Mode Memory Channel Number is something other than 0 to indicate a group call has been received.

Err will appear in the display if there is a problem in code identification.

To increase efficiency we recommend cancelling the paging mode after initial calls have been made to prevent transmitting the Paging Code data each time the PTT switch is depressed.

4. TONE ALERT SYSTEM

The Tone Alert function will provide an audible alarm to signal when someone is transmitting on the frequency you are monitoring. Each band can be selected by the T.ALT function independently, and different alarm tones are produced for each band. During the T.ALT function you will not hear voice communication. When used in conjunction with the CTCSS function this would allow the transceiver to act similar to a private pager system!

4-1. Tone Alert Operation

1. Press the BAND SEL key to select the band to be operated.
2. Adjust each SQL control to the threshold point.
3. If you will be using the CTCSS function you should select the proper tone frequency and ensure the CT indicator is on in the display.
4. Press the F key, then the TONE/T.ALT key. T.ALT indicator will light .

NOTES

1. When using CTCSS the incoming signal must be present for approximately 1 second in order for the T.ALT to function properly.
2. If the DTSS function is used in conjunction with the Tone Alert function, Tone Alert is activated only when the same DTSS signal is received.
3. The tone alert function is not activated when CTCSS and DTSS signals are on.

5. When a signal is present:
The T.ALT indicator will flash.
The transceiver will beep for approximately 5 seconds.
The time since the signal was received will be displayed. The time display is updated by each new incoming signal.



6. During time display the T.ALT function can be released by pressing any front panel key.
7. The T.ALT function can be released by pressing the F key, then the TONE/T.ALT key again.

NOTES

1. You can hear a transmission when the PF key is pressed while the Tone Alert function is activated with the microphone PF key set to the MONITOR switch. (MONITOR page 22)
2. The automatic power off function works after 59 hours and 59 minutes plus one minute when it is used with the tone alert function.

4-2. Alarm Sound Selection

The transceiver provides three different Alarm sound.

1. Press the BAND SEL key for the band to select the Alert tone.
2. Turn the Power switch off.
3. Press and hold the F key and the SHIFT key then turn the Power switch on. The current Alert sound indicator will light.

Alert sound indicator

Low tone **bEL1**

High tone **bEL2**

Melody **bEL3**

4. Rotate the tuning control to select the desired Alert sound.
5. Press any key to return to previous mode.

SECTION 4 Useful information

1. MAINTENANCE

●GENERAL INFORMATION

Your transceiver has been factory aligned and tested to specification before shipment. Under normal circumstances the transceiver will operate in accordance with these operating instructions. All adjustable trimmers and coils in your transceiver have been adjusted at the factory and should only be readjusted by a qualified technician with proper test equipment. Attempting service or alignment without factory authorization can void the transceiver's warranty.

When operated properly, the transceiver will provide many years of service without requiring realignment. The information in this section gives some general service procedures which can be accomplished without sophisticated test equipment.

●SERVICE

Should it ever become necessary to return the equipment to your dealer or service center for repair, pack it in its original box and packing, and include a full description of the problems involved. Also include your telephone number. You need not return accessory items unless directly related to the service problem.

SERVICE NOTE:

Dear OM, if you desire to correspond on a technical or operational problem, please make your note short, complete, and to the point, and PLEASE make it readable.

Please list: Model and serial number.

The problem you are having.

Please give sufficient detail to diagnose. Information such as other equipment in the station, meter readings and anything else you feel might be useful in attempting diagnosis.

CAUTION:

Do not pack the equipment in crushed newspapers for shipment. Extensive damage may result during shipment.

NOTES:

1. Record the date of purchase, serial number and dealer from whom purchased.
2. For your own information, retain a written record of any maintenance performed on the unit.
3. When claiming warranty service, please include a photocopy of the bill of sale, or other proof of purchase showing the date of sale must accompany the transceiver.

2. IN CASE OF DIFICULTY

The problems described in this table are failures caused, in general, by improper operation or connection of the transceiver, not by defective components. Examine and check according to the following table.

Symptom	Probable cause	Corrective action
Indicators do not light and no receiver noise is heard when the POWER switch is turned on.	<ol style="list-style-type: none">1. Bad power cable or connections.2. Blown power supply fuse.	<ol style="list-style-type: none">1. Check cables and connections.2. Check for the cause of the blown fuse and replace the fuse.
No sound from the speaker. No signal can be received.	<ol style="list-style-type: none">1. Squelch is closed.2. With the TSU-7 : CTCSS is operating,	<ol style="list-style-type: none">1. Turn the SQL control counterclockwise.2. Press the TONE/T.ALT key to turn off the CTCSS.
No transmitter output.	<ol style="list-style-type: none">1. Microphone jack is not plugged in.2. Poor antenna connection.	<ol style="list-style-type: none">1. Plug jack in.2. Connect antenna securely.
Weak signal cannot be received.	Poor antenna connection.	Connect antenna securely.
Display is dark.	<ol style="list-style-type: none">1. Power voltage is low.2. DIM had been set too dark.	<ol style="list-style-type: none">1. Check voltage for 13.8 VDC \pm15 %.2. Press the F key and the LOW/DIM key. See page 48.
No memory back up.	Backup battery voltage is low.	See Microprocessor memory backup page 37.
The display does not change when the tuning control is rotated.	<ol style="list-style-type: none">1. The LOCK function is on.2. The ALL LOCK function is on.	<ol style="list-style-type: none">1. Press the F key, then press the MHz/LOCK key within 10 seconds.2. Hold down the MHz/LOCK key, switch the power on, then perform step 1 again.

Symptom	Probable cause	Corrective action
DTSS or paging does not work through the repeater.	The repeater ID overlaps with data, so the remote station cannot receive the code properly.	Release the PTT, confirm that no ID is transmitted, and then press PTT again.
DTSS or paging does not work.	The remote transceiver is in the battery save mode.	Press PTT again.
The S meter pointer stops midway, and only strong signals can be received.	S meter squelch is set.	Cancel S meter squelch.
The receive tone breaks up.	The SQL control has been turned too far clockwise.	Select a channel in which there is no signal, and set the control to the position where the noise disappears.
Squelch turns on whenever a signal comes in, even if paging is set.	Signaling squelch has been canceled.	Turn the POWER switch off, hold down the VOL control for the band for which paging is set, then press the POWER switch.

The following formula can be used to help determine if a particular frequency combination will cause interference/birdies.
 $(\text{VHF band UHF receive frequency} - 45.05) \times 2 - (\text{UHF band receive frequency} - 58.525) \times 2 = 45.05 \text{ MHz}$

3. OPTIONAL ACCESSORIES

CTCSS UNIT

TSU-7



MULTI FUNCTION
MICROPHONE
MC-45/45E

(E;European version)



MOBILE SPEAKER

SP-41



MULTI FUNCTION
MICROPHONE WITH DTMF
MC-45DM/45DME



COMMUNICATIONS
SPEAKER

SP-50B



DETACHABLE FRONT
PANEL KIT
PG-4K



DETACHABLE FRONT
PANEL KIT
PG-4L



DC LINE
NOISE FILTER
PG-3G



DC POWER SUPPLY

PS-33



DC POWER
CABLE
PG-2N



DC POWER SUPPLY

PS-53



MICROPHONE
PLUG ADAPTOR
MJ-88



4. INSTALLING OPTIONAL ACCESSORIES

4-1. CTCSS unit (TSU-7)

1. Remove the four screws holding the top cover.
2. Remove the top cover.
3. Insert the TSU-7 into the specified connector. Install it on the PC board under the flat cable on the front left side, as viewed from the panel.

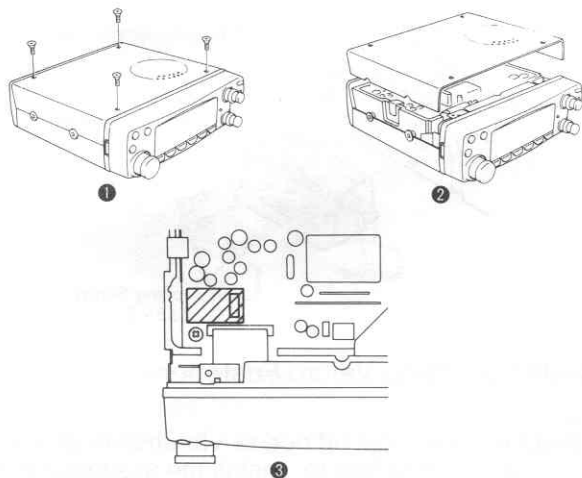

4. Install the top cover.

4-2. PANEL SEPARATION KIT (PG-4K/4L)

1. Press the release button on the left of the front panel.
2. Hold the left side of the front panel, and slowly pull the panel forward.
3. Remove the connector cover on the chassis side.
4. Disconnect the connector, and pull the cord out.
5. Remove the connector cover on the front panel side.
6. Remove the connector, and pull the cord out.
7. Install the panel separation kit.
8. Fit the cord grommet into the groove.
9. Reinstall the connector covers on the front panel and chassis.

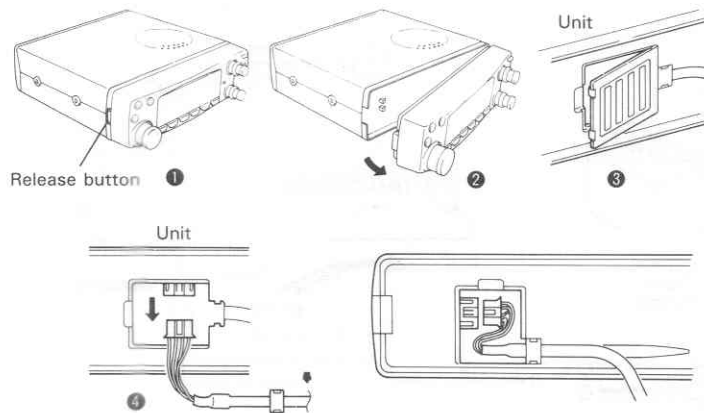

PG-4K

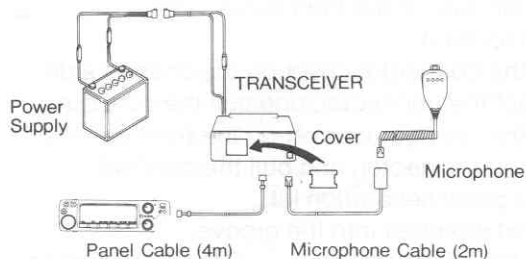

PG-4L

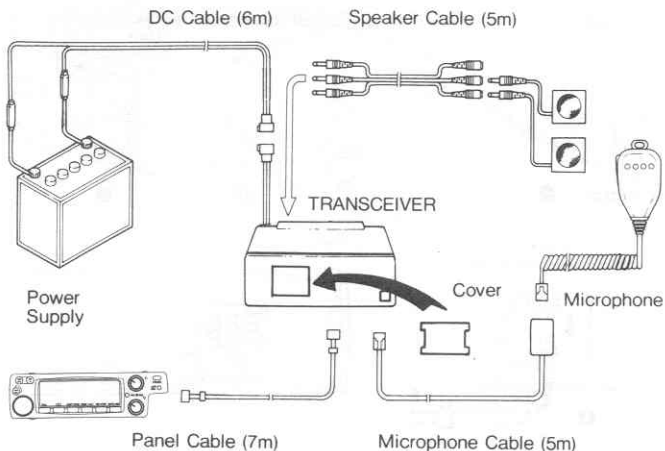

BRACKET

Loosen the bracket screws and put the two plates at right angles. Attach the front panel unit to the bracket using the three supplied screws. Install the bracket using the supplied flat washers and screws.

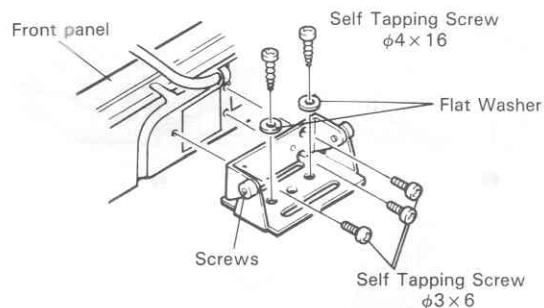

● Installation Using Velcro Fastener

NOTE

The bracket may come off due to vibration or shock when installed using Velcro. Install the assembly in a safe position near the console, or storage compartment (indicated by the lines) to ensure safety.

Peel the backing on the supplied Velcro tape and attach it to the back of the front panel unit. Securely install the front panel in a stable position.

5. SPECIFICATIONS

		144 MHz Band	440 MHz Band	
GENERAL	Frequency range MHz	U.S.A. and Canada	144 ~ 148	438 ~ 450
		Other market	144 ~ 148	430 ~ 440
		TM-732E	144 ~ 146	430 ~ 440
	Mode	F3E (FM)		
	Antenna impedance	50Ω		
	Operating temperature	-20°C ~ +60°C (-4°F ~ +140°F)		
	Power requirements	13.8VDC ± 15% (11.7 ~ 15.8V)		
	Ground	Negative		
	Current drain	Transmit mode	Less than 11.5A	Less than 10.0A
		Receiver mode	Less than 1.2A	
Frequency stability	± 10ppm			
Dimensions (W×H×D)	141 × 42 × 175 mm			
Weight	1.1 kg			
TRANSMITTER	Output power	HI	50W	35W
		MID	10W	
		LOW	Approx. 5W	
	Modulation	Reactance modulation		
	Spurious radiation	Less than -60dB		
	Maximum frequency deviation	± 5 kHz		
	Audio distortion (at 60% modulation)	Less than 3%		
	Microphone impedance	600Ω		
RECEIVER	Circuitry	Double conversion superheterodyne		
	Intermediate frequency 1st/2nd	45.05MHz/455 kHz	58.525MHz/455 kHz	
	Sensitivity (12 dB SINAD)	Less than 0.16μV (-10 dBμ)		
	Selectivity -6 dB	More than 12 kHz		
	Selectivity -60 dB	Less than 24 kHz		
	Squelch sensitivity	Less than 0.1 μV (-14 dBμ)		
	Output (5% distortion)	More than 2 W (8Ω load) (5% distortion)		
	External speaker impedance	8Ω		

NOTES

1. Circuit and ratings are subject to change without notice, due to developments in technology.
2. Recommended duty cycle: 1 minute Transmission, 3 minutes Reception.